

Regulační klapka

DRU



Popis

Klapka DRU má seříznutý list. Je plynule nastavitelná od 0°-90°. Uložení regulace umožňuje izolaci rozvodu až 50mm.

List klapky je navržen tak, aby generoval minimum hluku. Hluk je cca. stejný jako u perforovaného listu. List je však méně citlivý vůči zanesení, protože nemá perforaci.

Nastavený úhel α

$\alpha = 0^\circ$ = otevřený list, $\alpha = 90^\circ$ = zavřený list

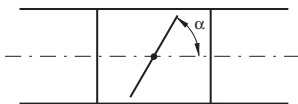

Pro tento produkt existuje samostatný návod na montáž, měření, vyvažování a údržbu.

Ø 80–1000 splňuje třídu těsnosti A v zavřené poloze.

Kalíšek o Ø 80–630 lze doplnit speciální izolační miskou IK pro izolaci silnější než 50 mm.

Zesílený list

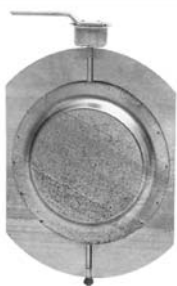

Příklad objednání

Výrobek DRU 125
Rozměr Ød₁

Rozměry

Ø 80–630

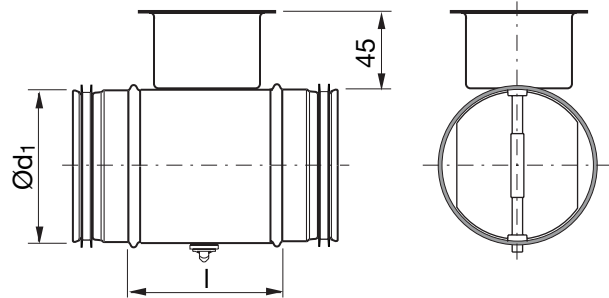

Ø 800–1000

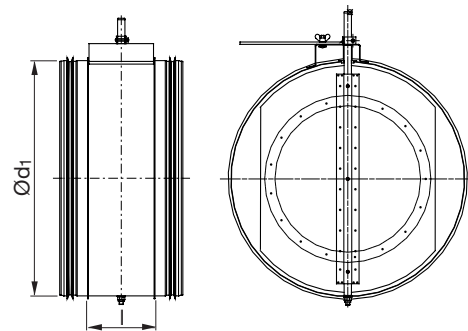

Ød ₁ nom	l [mm]	m [kg]	Třída těsnosti se zavřeným listem
80	100	0,34	0
100	100	0,40	0
112	100	0,43	0
125	100	0,46	0
140	100	0,54	0
150	100	0,60	0
160	100	0,65	0
180	100	0,69	0
200	100	0,80	0
224	100	0,90	0
250	100	1,28	0
280	100	1,40	0
300	100	1,62	0
315	100	1,70	0
355	100	2,01	0
400	100	2,82	0
450	100	3,70	0
500	115	4,70	0
560	115	5,51	0
600	115	5,90	0
630	115	6,21	0
800	230	18,2	0
1000	230	24,4	0



Regulační klapka

DRU

Vlastnosti	Ø 80-315	Ø 400	Ø 500	Ø 630	Ø 800x1000
The blade is set via a knob in a protective cup.	x	x	x	x	
The setting of the blade is read against an embossed scale at the rim of the cup.	x	x	x	x	
The blade is locked with two screws, type Pozidriv (PZD2).	x	x	x	x	
The blade has reinforced locking with a sturdy wing nut.					x
The blade is reinforced.			x	x	
The blade is additionally reinforced.					x
With sturdy handle.		x	x	x	
With additionally reinforced handle.					x
With reinforced stop beads.			x	x	
The axle is reinforced.					x
The damper can be delivered prepared for motor.	x	x	x	x	
The damper can be delivered with motor.	x	x	x	x	x

Technická data

Pressure drop graphs with noise data for dimensioning

The solid curves show the pressure drop, Δp_t , over the damper as a function of flow q , and setting angle α . The dashed curves give the A-weighted sound power data, L_{WA} , in dB to the duct.

Example

Given

Dimension Ø100
Flow 60 l/s
Pressure drop 200 Pa

Obtained from graph

Setting angle 40°
Sound power level 63 dB (A)

Ø80

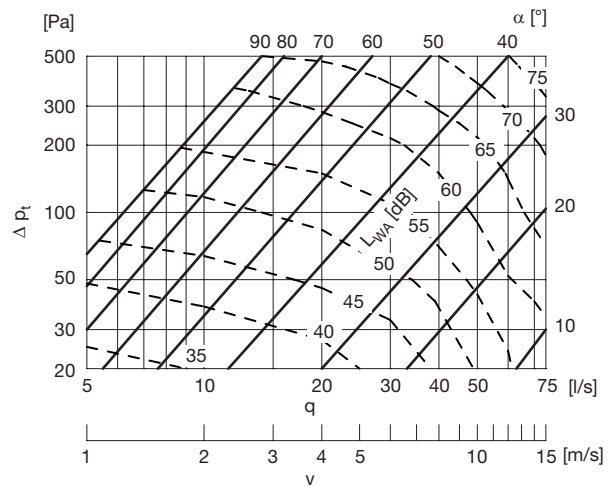

Ø100

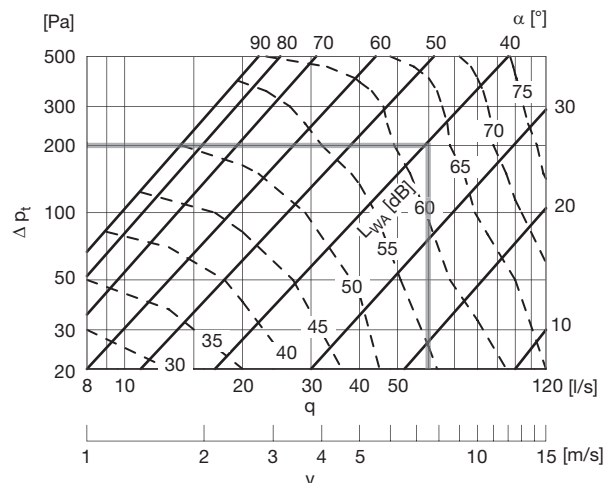

Regulační klapka

DRU

Ø112

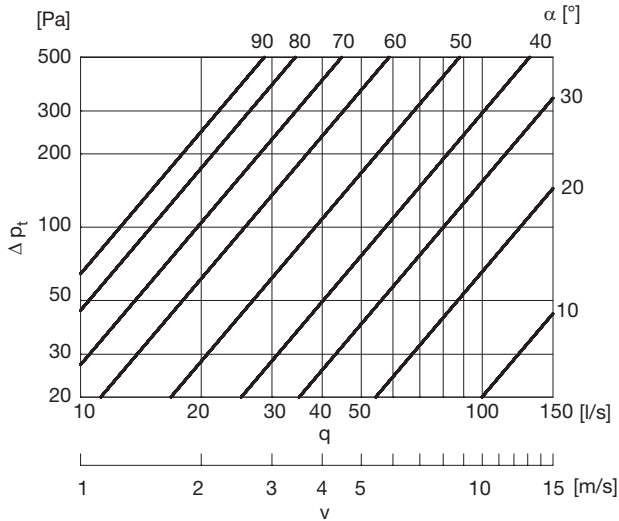

Ø150

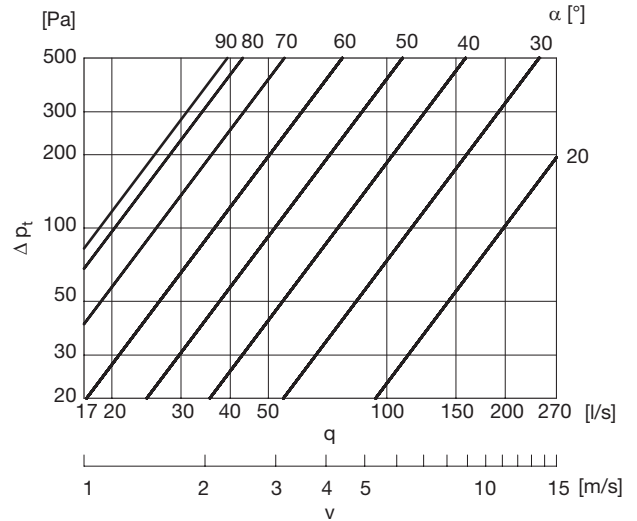

Ø125

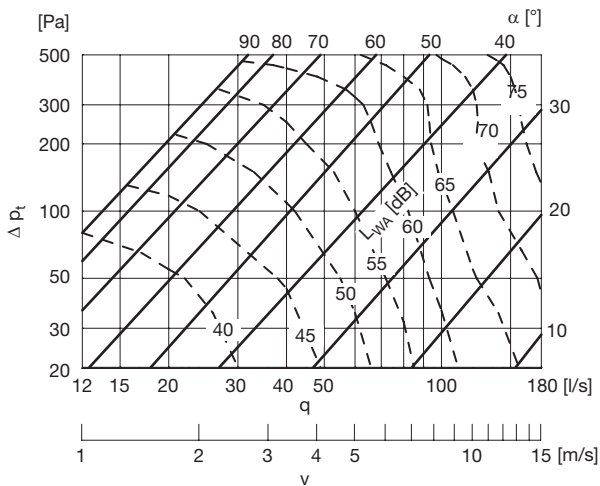

Ø160

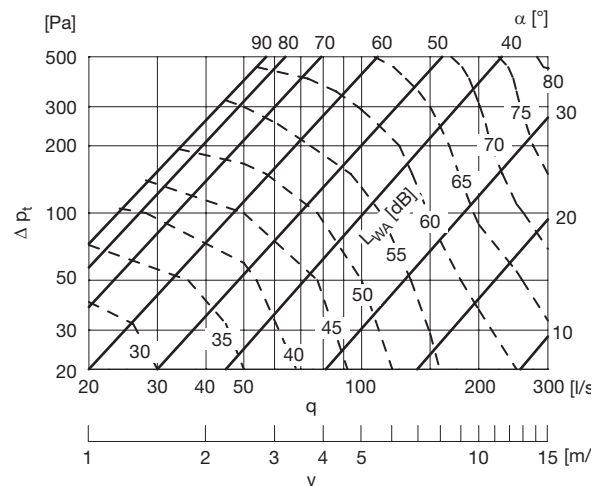

Ø140

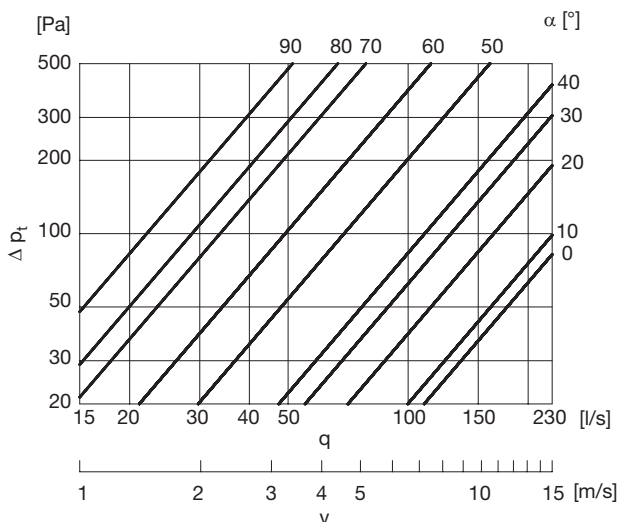

Ø180

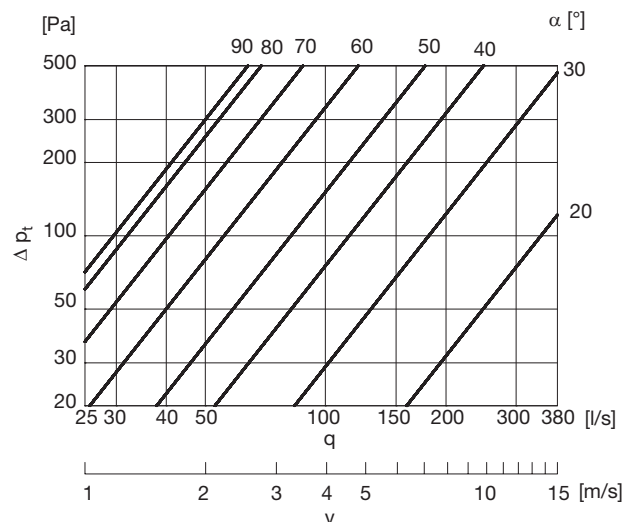

Regulační klapka

DRU

Ø200

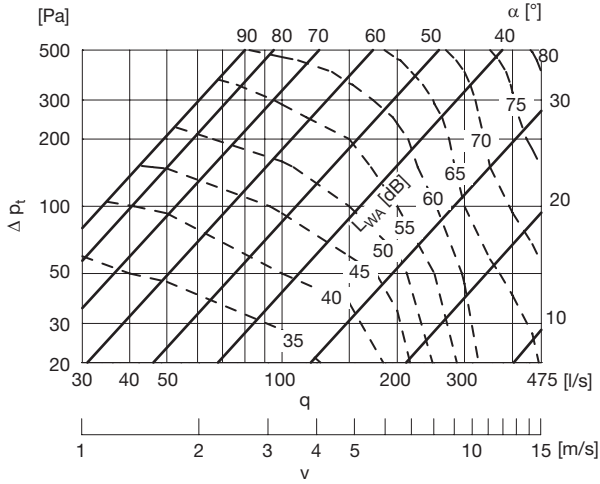

Ø280

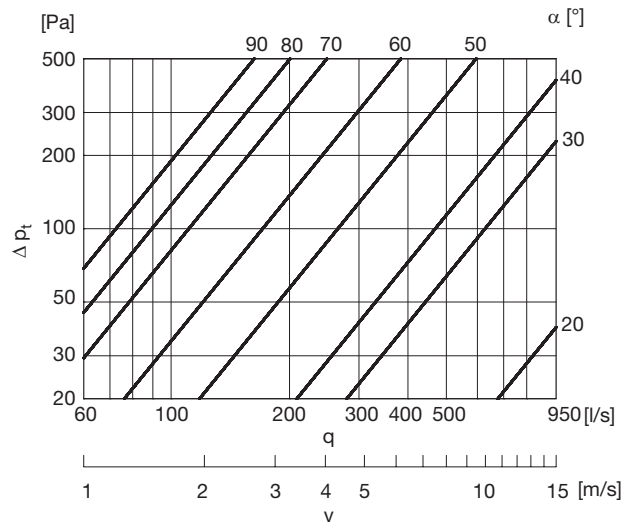

Ø224

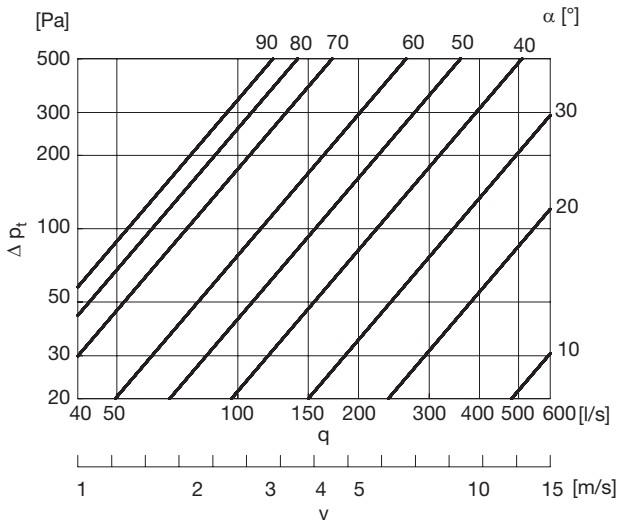

Ø300

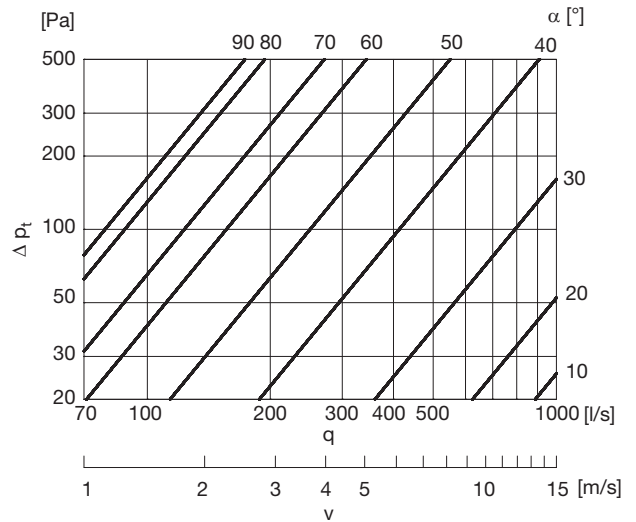

Ø250

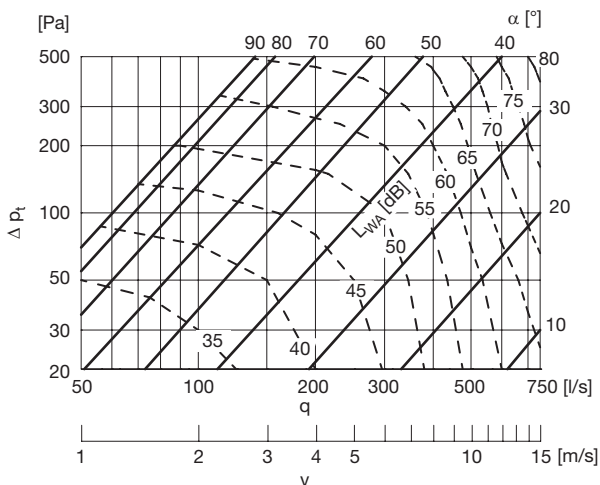

Ø315

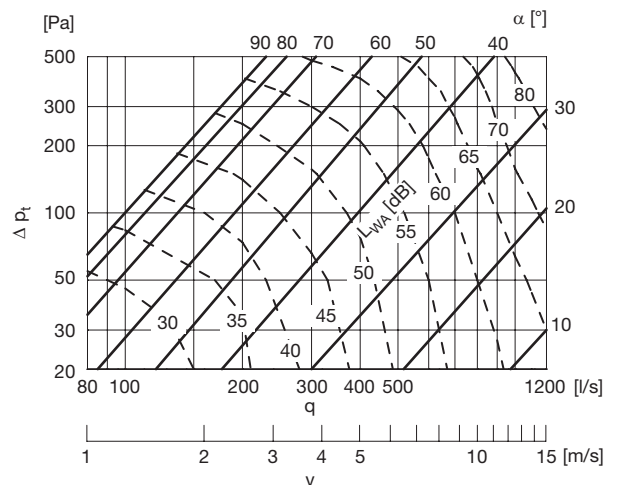

Regulační klapka

DRU

Ø355

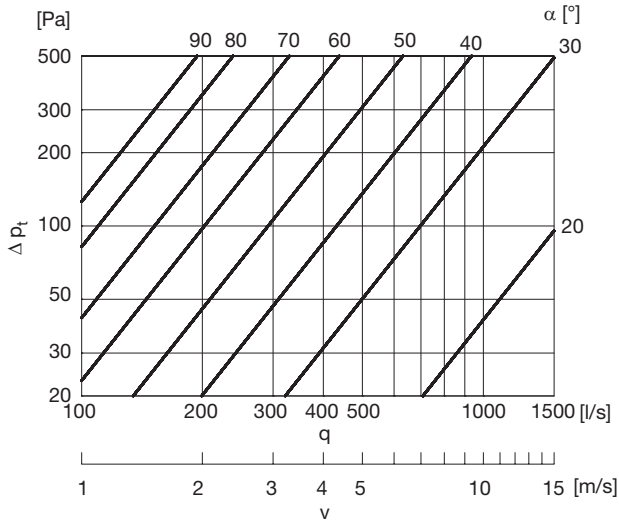

Ø500

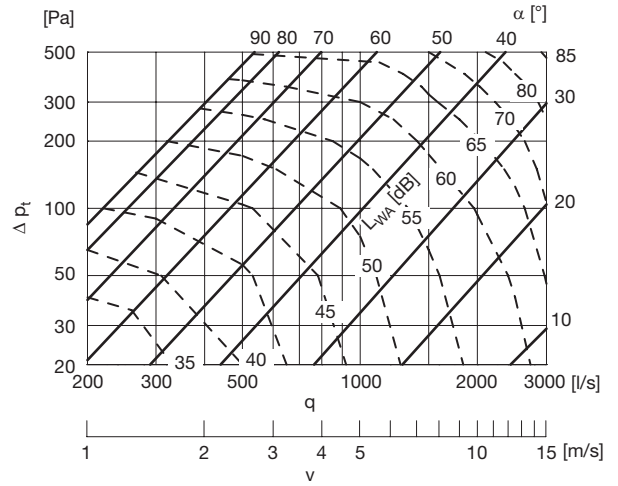

Ø400

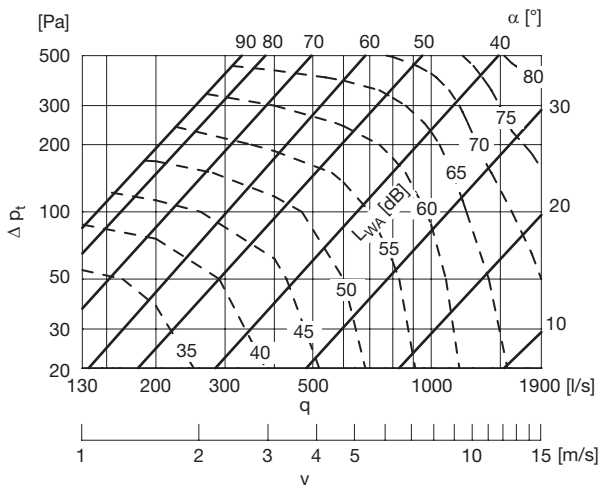

Ø560

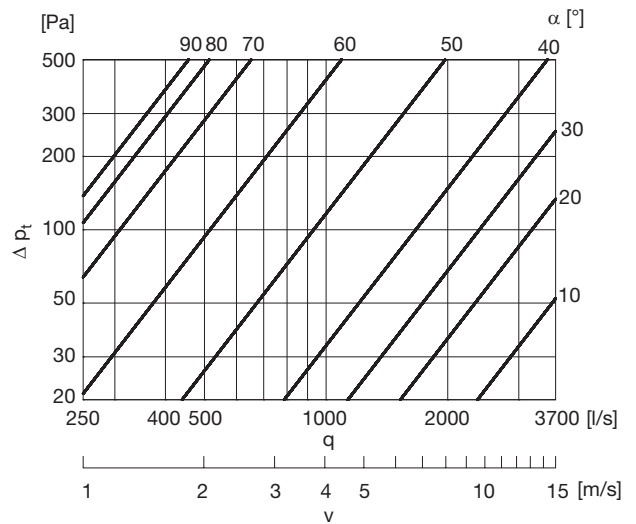

Ø450

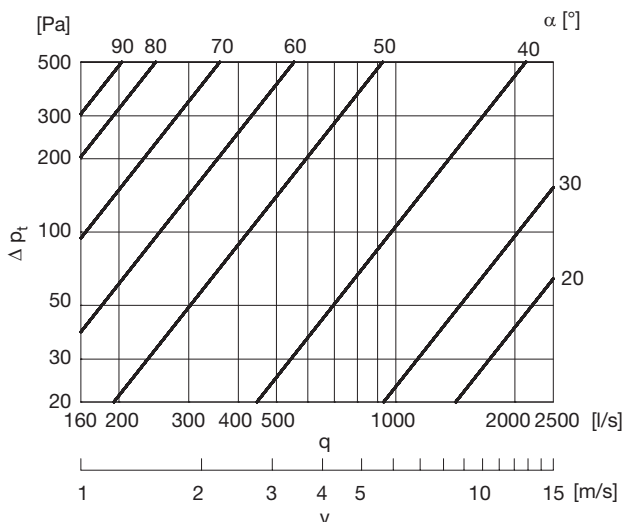

Ø600

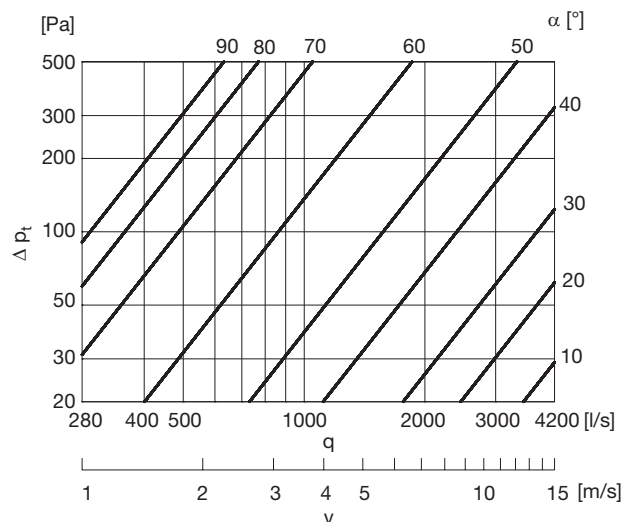

Regulační klapka

DRU

Ø630

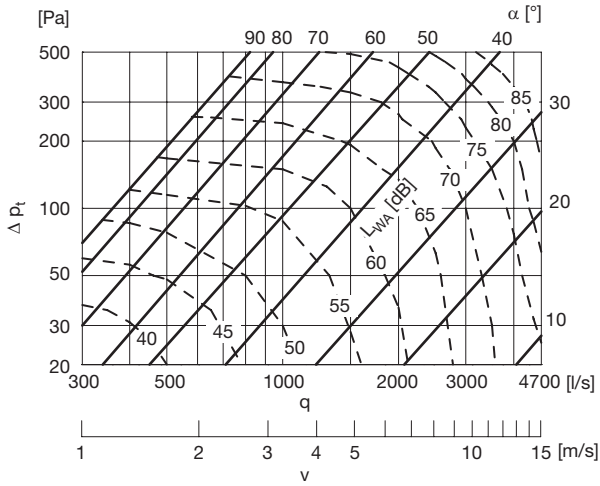

Ø900

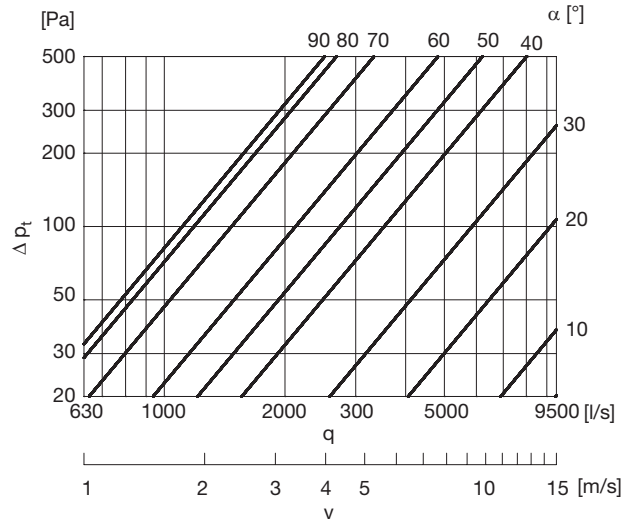

Ø710

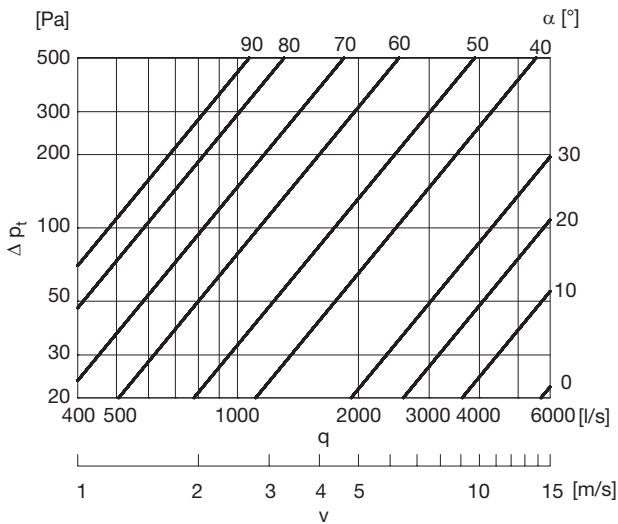

Ø1000

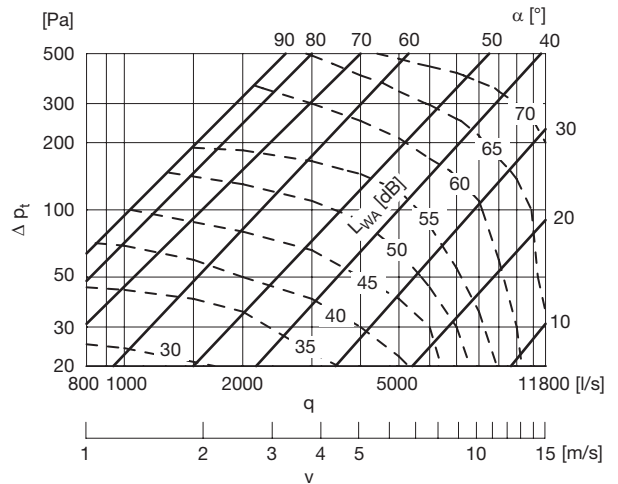

Ø800

