



Lindab **Plexus**

Quick Installation Guide



Quick Installation Guide

Plexus

Symbols



Hot water



Hand-pull



Cold water



Heavy Load - 2 man job
- It is recommended to use a "lift" for mounting.

Tools



Knife



Gloves



Shoes with soft soles

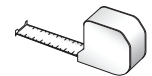

Tape measure

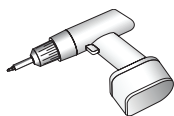

Drill machine

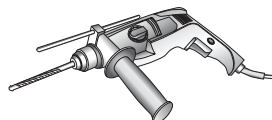

Percussion drill

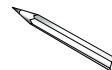

Pencil

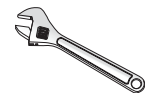

Spanner

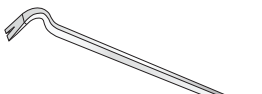

Crowbar

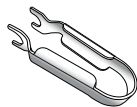

Tectite tool 12mm
(Order no: 884087)



Tectite tool small 12mm
(Order no: 646881)

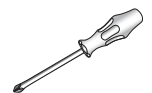

Screwdriver



Spirit level



Lindab PC410
(Order no: 103344)

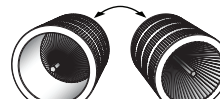

Deburring tool

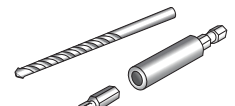

Bits and drills



Vacum cleaner



Dust-cleaner

Quick Installation Guide

Plexus

Packing and unpacking

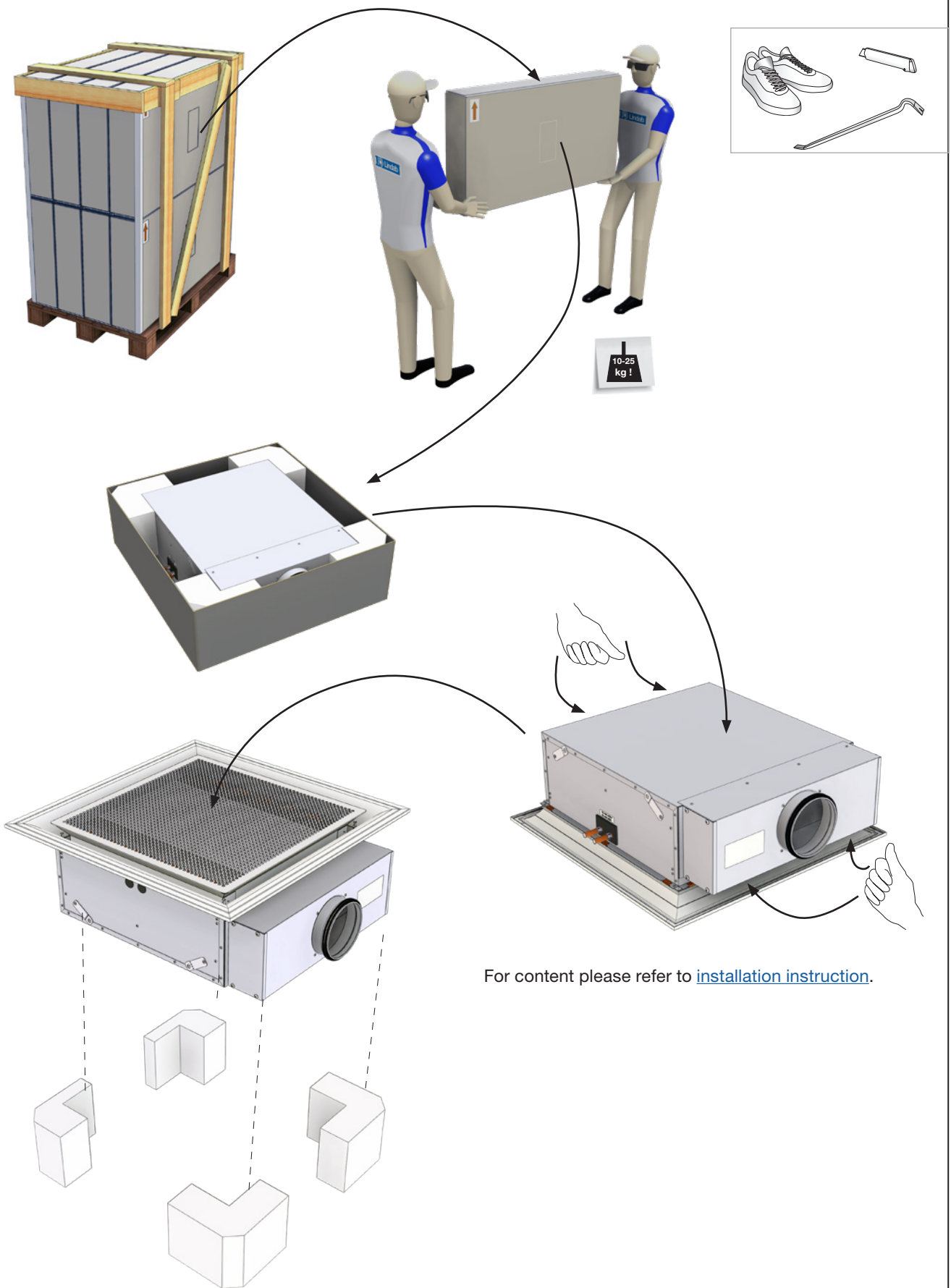

For content please refer to [installation instruction](#).

Quick Installation Guide

Plexus

Order code label

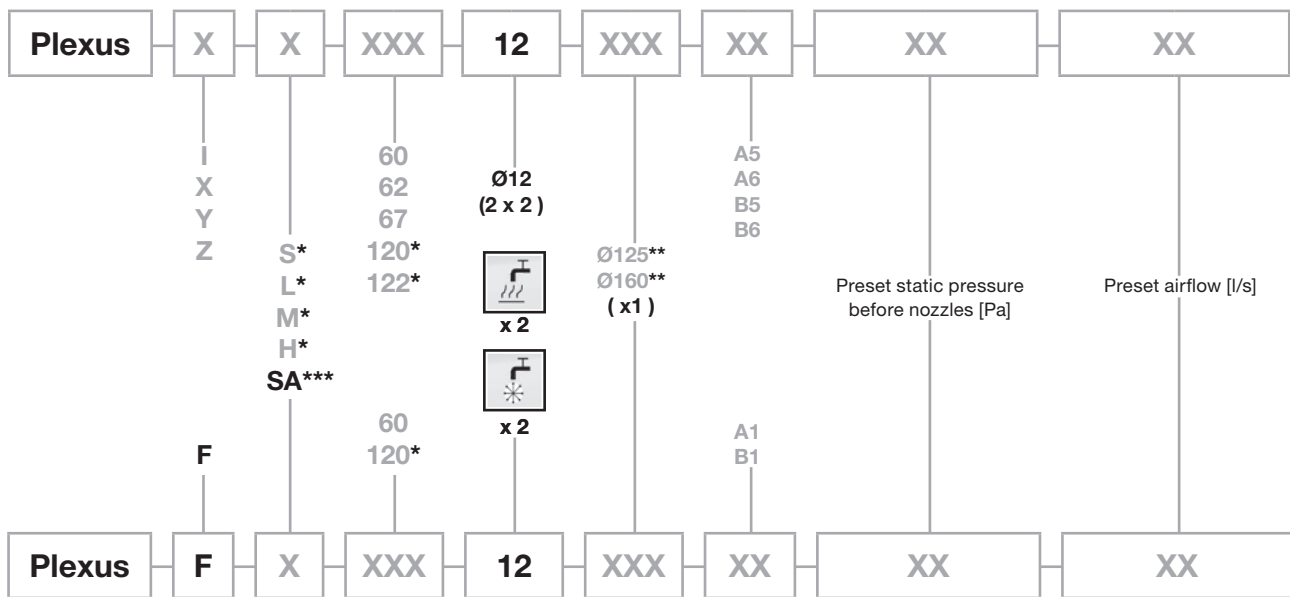
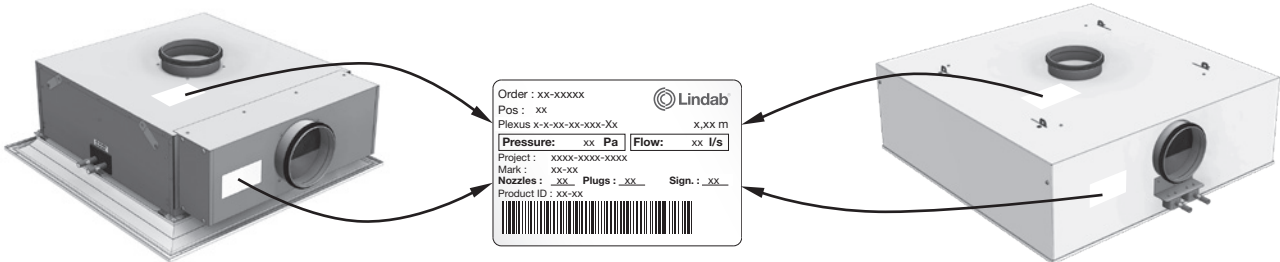

* 120 and 122 only available when **S-configuration** has been selected. **L, M, H configurations** only available in 60, 62, 67 versions.
 ** \varnothing_H (Side air connection (A)) = 125 only.
 ** \varnothing_V (Top air connection (B)) = 125 only for S-configuration. $\varnothing_V = 160$ only for **L, M, H configurations**.
 (See also dimension table 3.2 in [installations instruktion](#)).
 ***The type SA (integrated steel frame) is available for version ISA-60 and 120 only (for T24/T15 lay-in 600 (ceiling type 1))

Product labelling

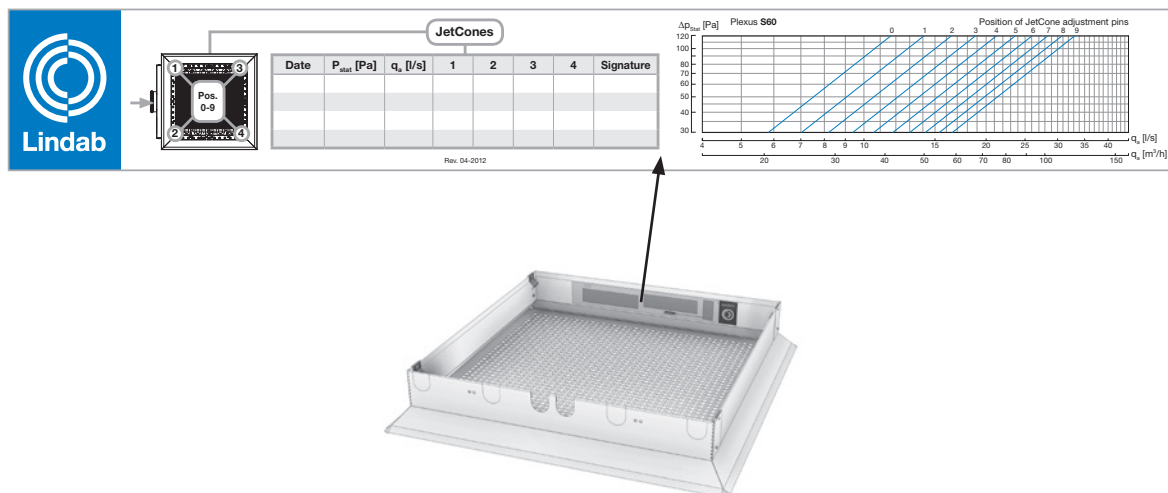

Quick Installation Guide

Plexus

Dimensions

Plexus I, (X, U, Y, Z)

I 60



I 120

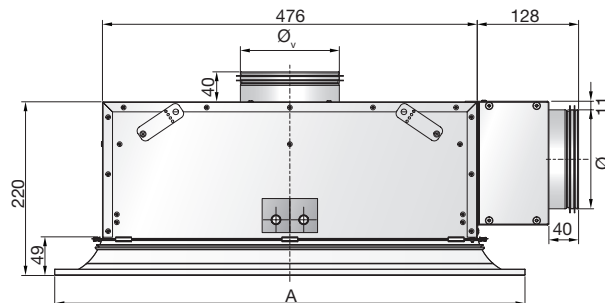
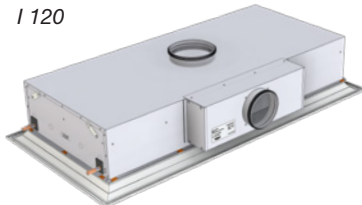

	A mm	B mm	Ø _H mm	Ø _V mm	
I (S, SA, L, M, H) 60	594	594	125	125/160	1, 2, 3, 8
X (S, L, M, H) 60	599	599	125	125/160	4, 5, 6, 7, 14
U (S, L, M, H) 60	599	599	125	125/160	USA 2' x 2'
Y (S, L, M, H) 60	575	575	125	125/160	9, 11
Z (S, L, M, H) 60	584	584	125	125/160	10
I (S, L, M, H) 62	619	619	125	125/160	21
I (S, L, M, H) 67	669	669	125	125/160	31, 32
I S/SA 120	594	1194	125	160	1, 2, 3, 8
X S 120	599	1199	125	160	4, 5, 6, 7, 14
Y S 120	575	1174	125	160	9, 11
Z S 120	584	1183	125	160	10
U S 120	599	1209	125	160	USA 2' x 2'
I S 122	619	1244	125	160	21

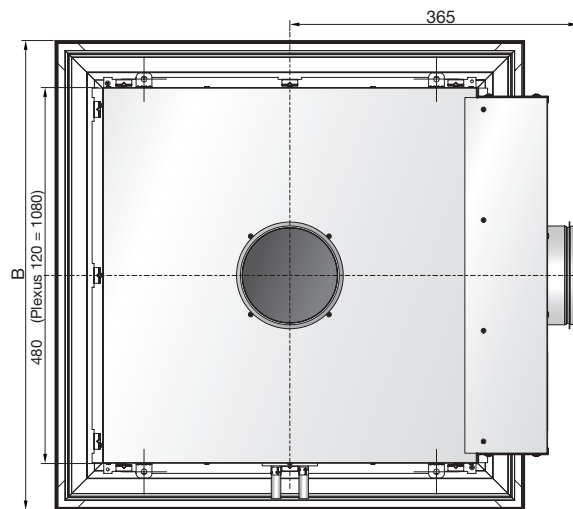

! Plexus (I, X, Y, Z) - (S) => Ø_v = 125 Plexus (I, X, U, Y, Z) - (L, M, H) => Ø_v = 160

Plexus F

F 60

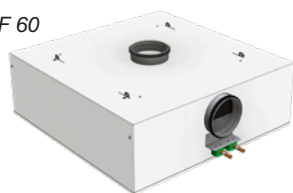

F 120

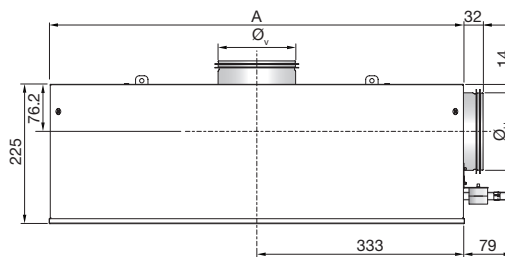
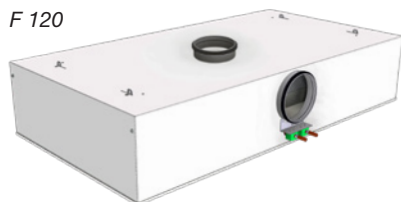

	A mm	B mm	Ø _H mm	Ø _V mm
F (S, L, M, H) 60	669	669	125	125/160
F S 120	669	1269	125	160

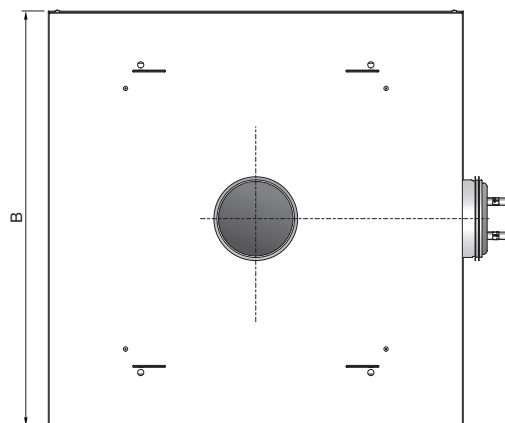

! Plexus (F) - (S) => Ø_v = 125 Plexus (F) - (L, M, H) => Ø_v = 160

Quick Installation Guide

Plexus

Material data

Type	Plexus I 60	Plexus I 120		Plexus F 60	Plexus F 120	
	Cooling/Heating	Cooling/Heating		Cooling/Heating	Cooling/Heating	
Dry weight, kg	11.6	18.6	20	17.2	28.9	30.3
Water content, cooling, l	1.0	1.3		1.0	1.3	
Water content, heating, l	0.2	0.4		0.2	0.4	
Water content, cooling only, l	1.2	1.3		1.2	1.3	
Copper pipes, quality	EN-12735-2-CU-DHP					
Pressure class	PN10					

Environmental Declarations

Please follow the links below

- [Building product declaration](#)
- [Declaration of conformity](#)
- [Eurovent certificate](#)

Pressure Class

The waterborne products in Lindab, active chilled beams (battery products), passive chilled beams (battery and strips products), facade units (battery) and radiant panels (strips and panels) are produced according to pressure class PN10 according to EN 1333: 2006.

This means the maximal working pressure for the products at a water temperature of 20°C must not exceed 10 bar.

Quick Installation Guide

Plexus

Water connections

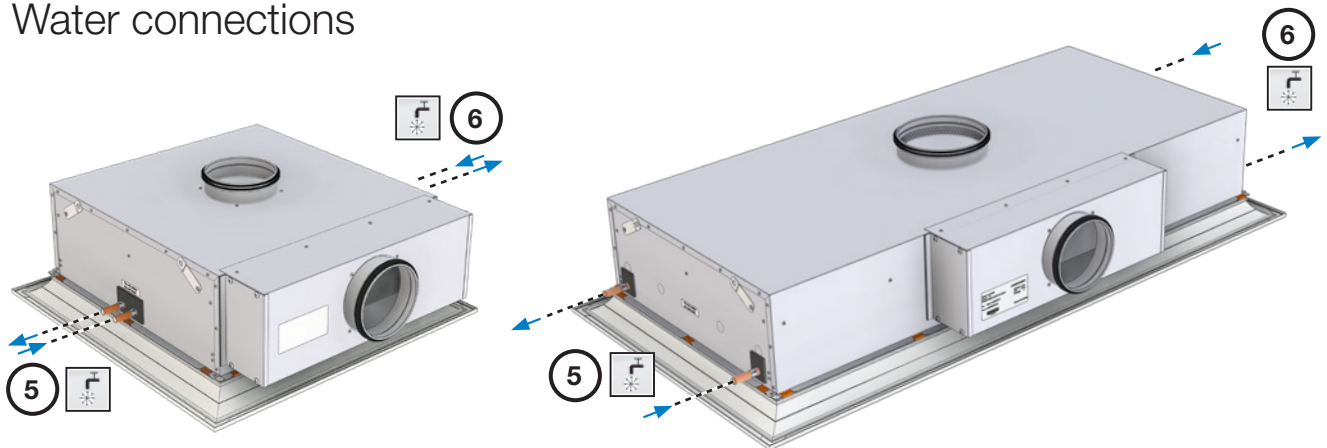

Plexus 60: I, (X, U, Y, Z)
Cooling or heating. (standard)

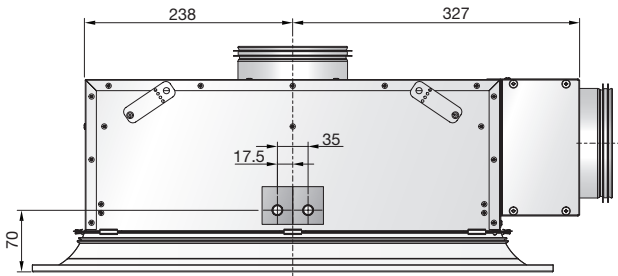

Plexus 120: I, (X, U, Y, Z)
Cooling or heating. (standard)

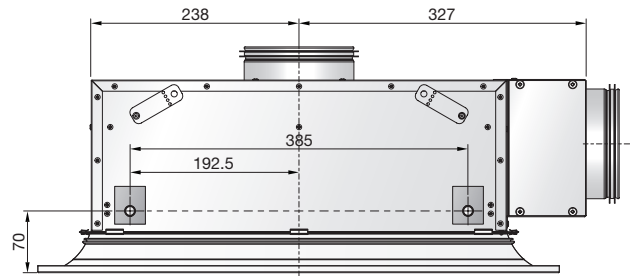

Plexus 60: I, (X, U, Y, Z)
Cooling and heating

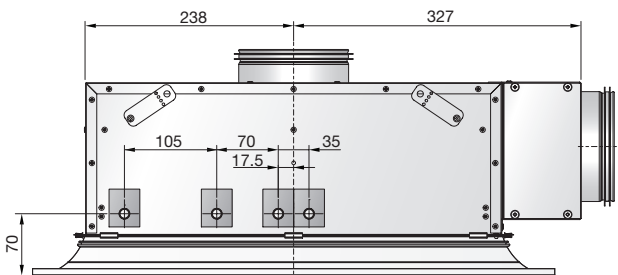

Plexus 120: I, (X, U, Y, Z)
Cooling and heating

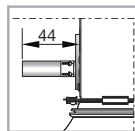
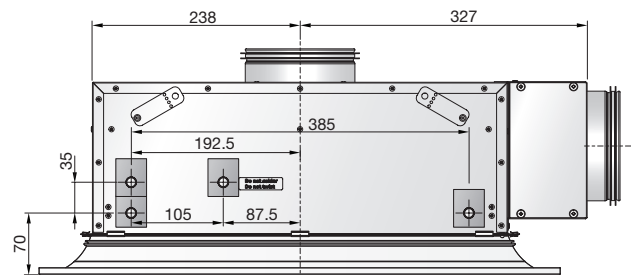

Plexus 60/120 : I, (X, U, Y, Z). Cooling and heating. In /outs

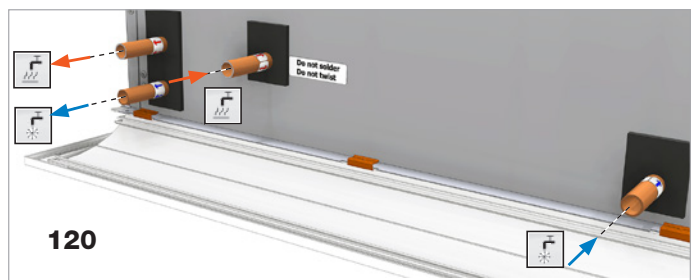
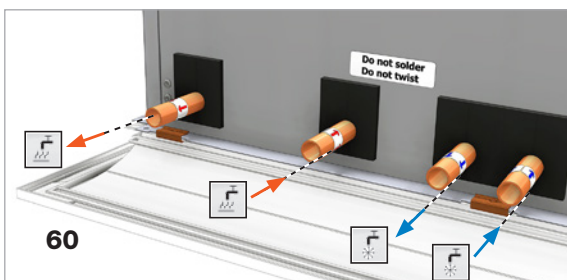

Quick Installation Guide

Plexus

Water connections

Plexus F 60: cooling or heating (standard)

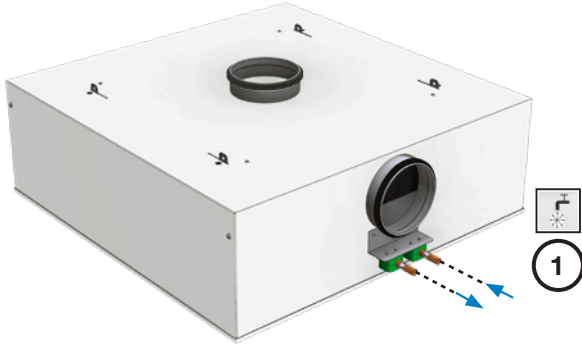

Plexus F 120: cooling or heating (standard)

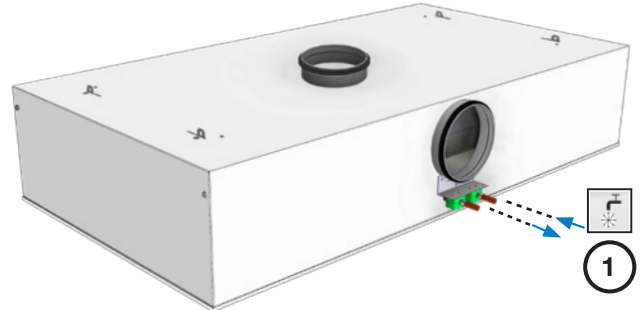

Plexus F 60: cooling and heating.

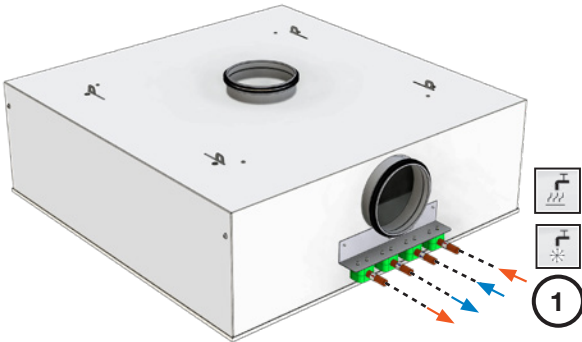

Plexus F 120: cooling and heating.

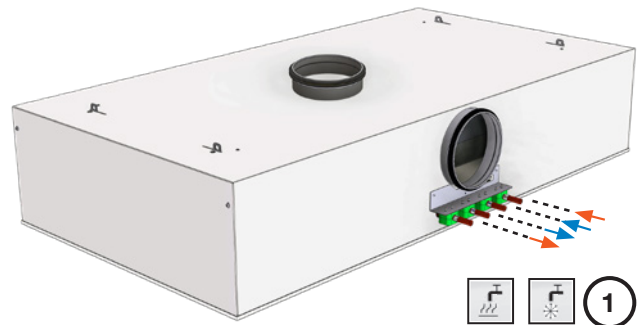

Plexus F 60/120: cooling or heating. (standard)

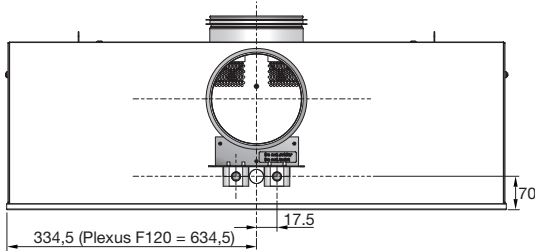

Plexus F 60/120: cooling and heating

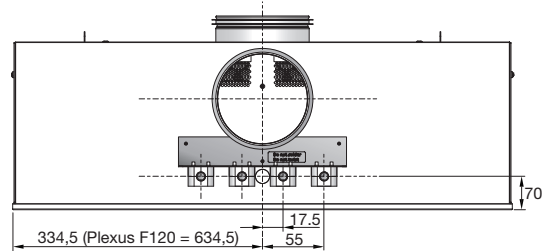

Plexus F 60/120: cooling or heating (standard)

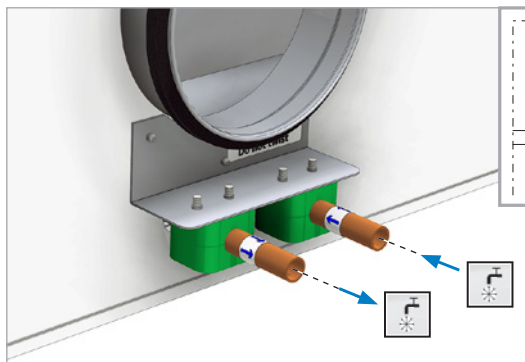

Plexus F 60/120: cooling and heating

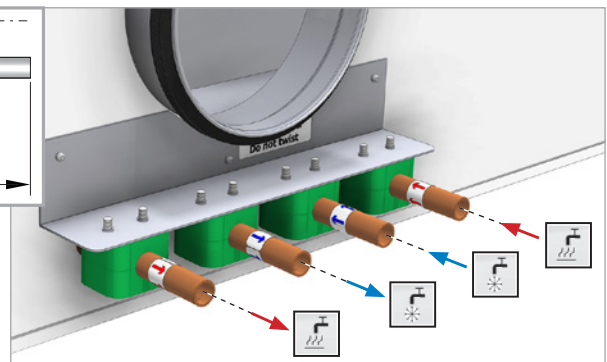

Quick Installation Guide

Plexus

Before installation

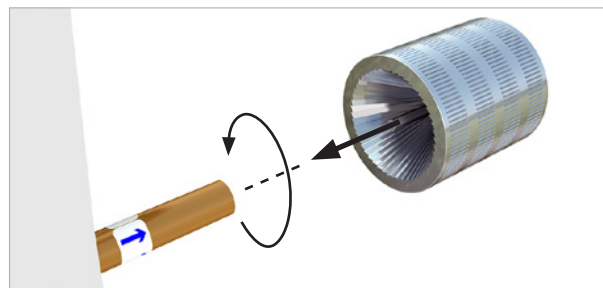
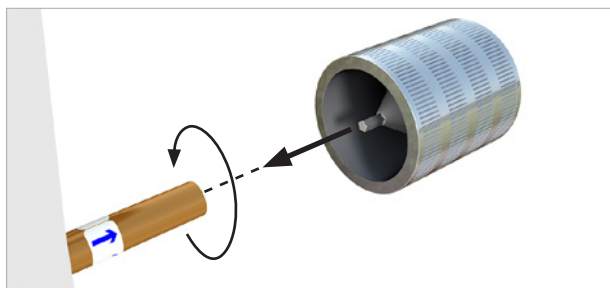
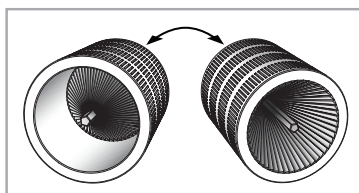
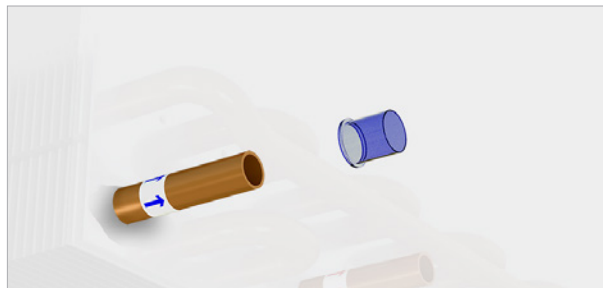

Flexible hoses and Push-on valves

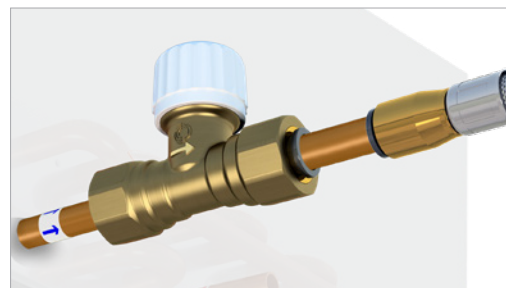
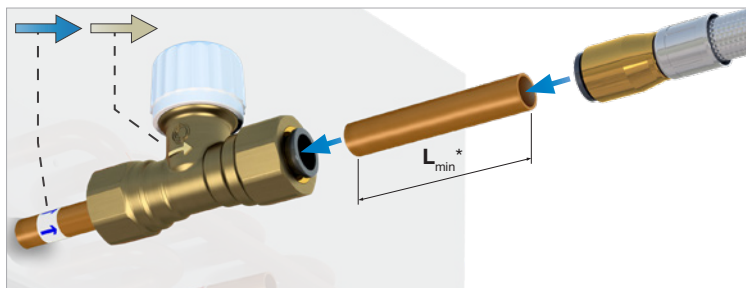
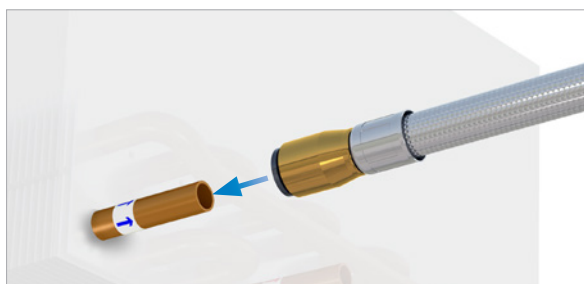

* $L_{min} = 70 \text{ mm}$ (to ensure you can open the couplings again).

Lindab flexible hoses are available with straight end (male) for direct connection to Lindab valves also.

Quick Installation Guide

Plexus

Connections

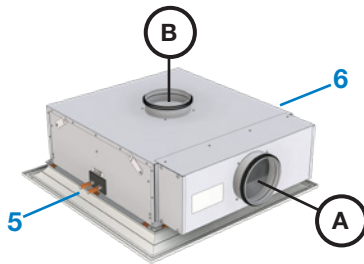

I, (X, U, Y, Z) 60

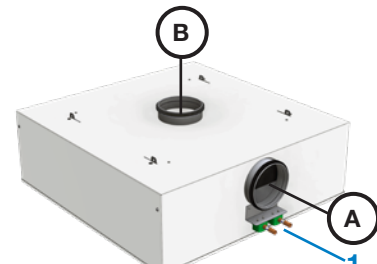

F60

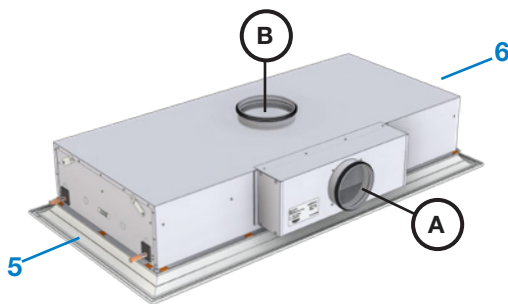

I, (X, U, Y, Z) 120

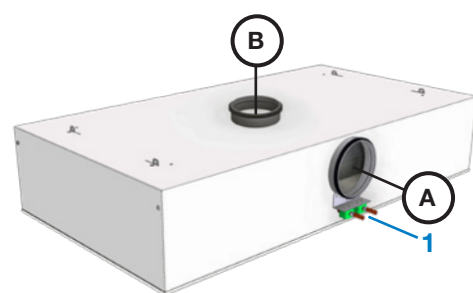

F120

Possible Plexus I, (X, U, Y, Z) connections

Supply air (A, B) and water (5, 6).

A5, A6, B5, B6

Possible Plexus F connections,

Supply air (A, B) and water (1).

A1, B1

Quick Installation Guide

Plexus

Electrical connections and valves

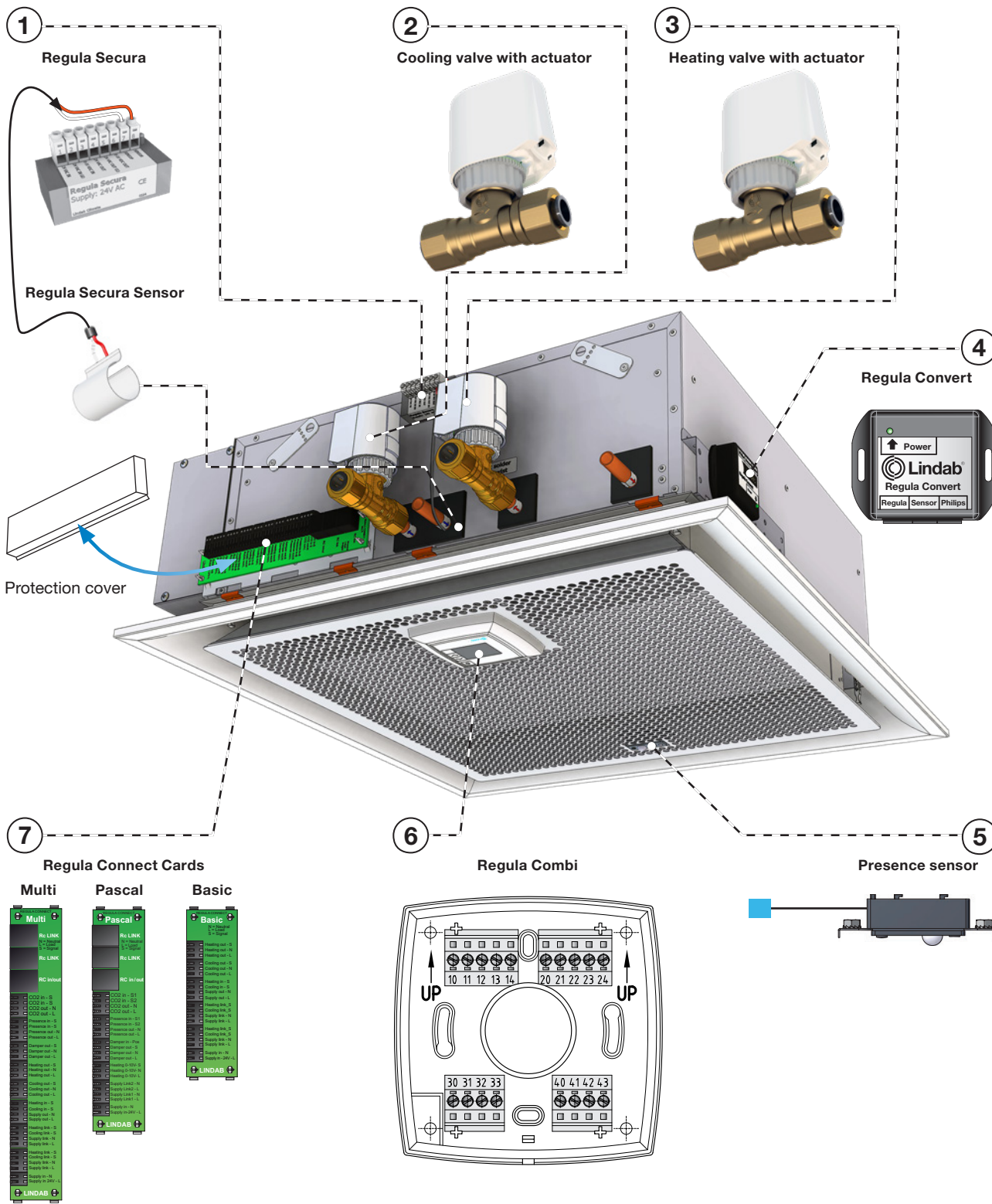

(with protection covers, optional)

Quick Installation Guide

Plexus

Installation

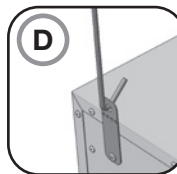
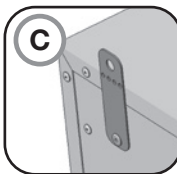
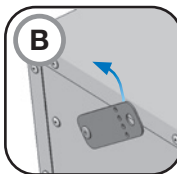
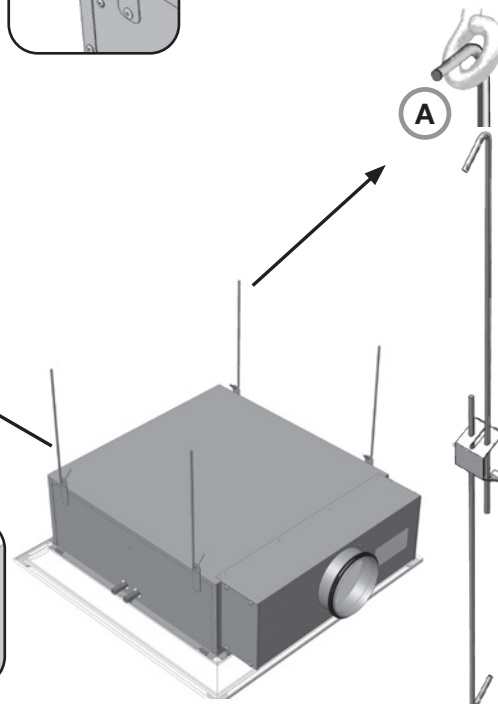
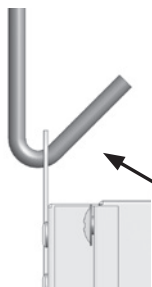
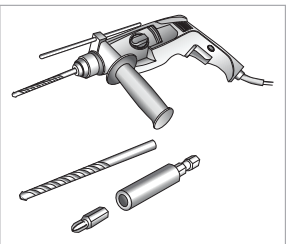
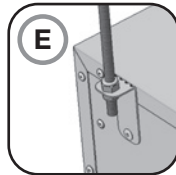
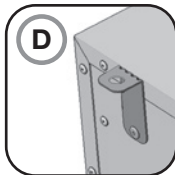
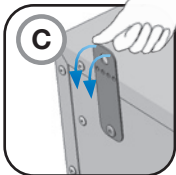
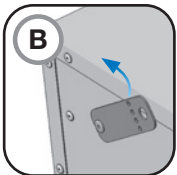
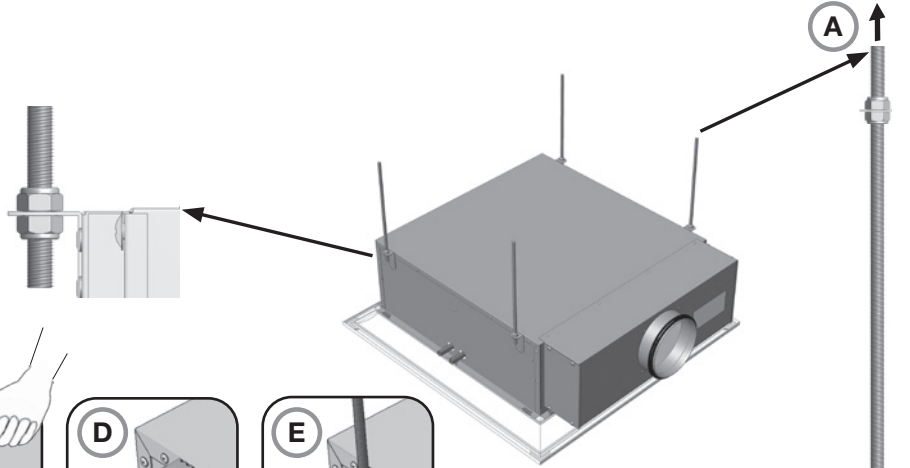
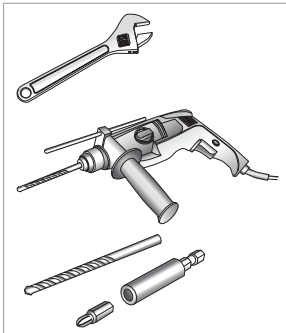
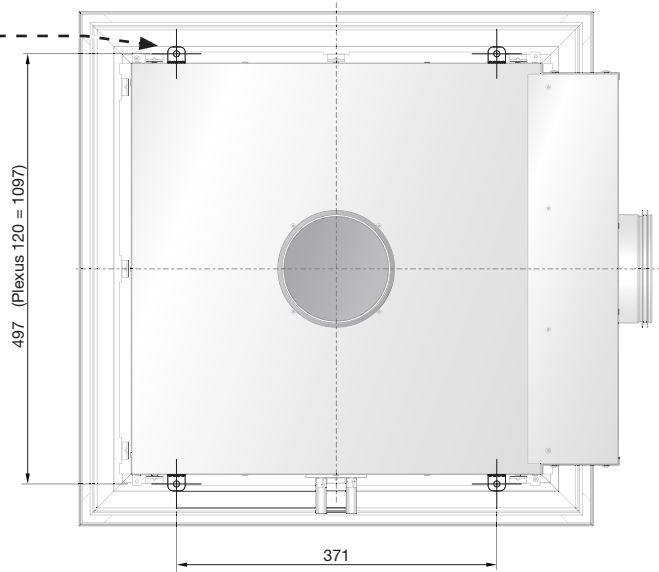
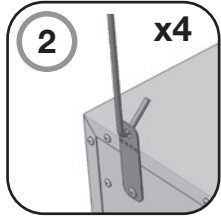
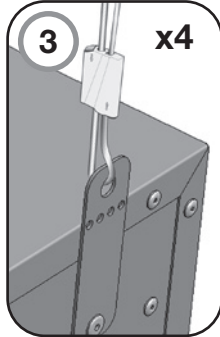
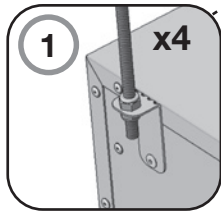

Quick Installation Guide

Plexus

JetCone adjustment

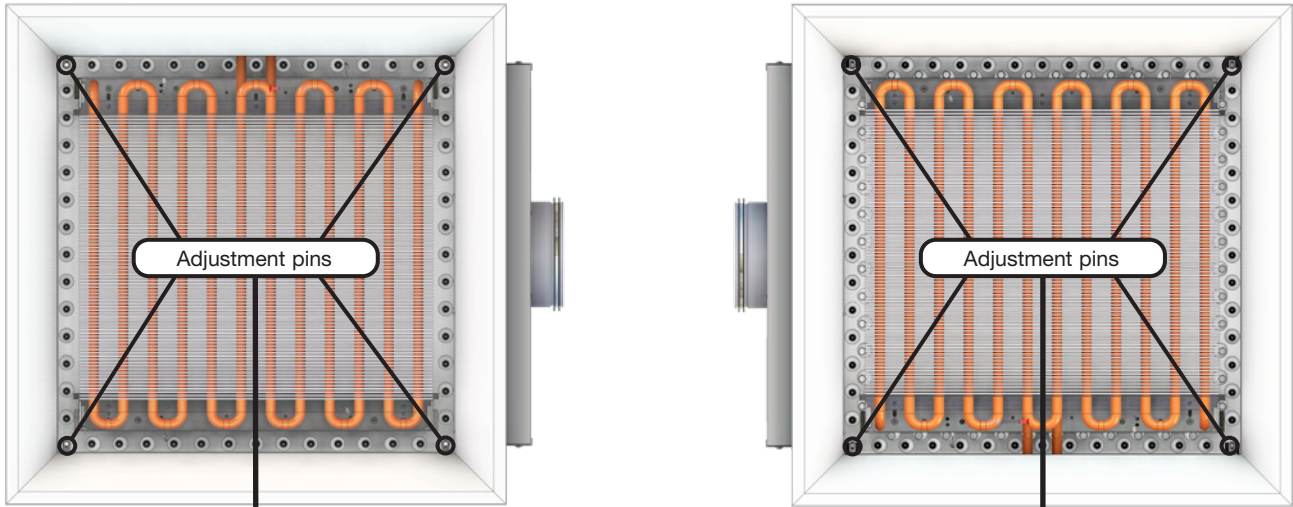

Plexus S/SA

x 4

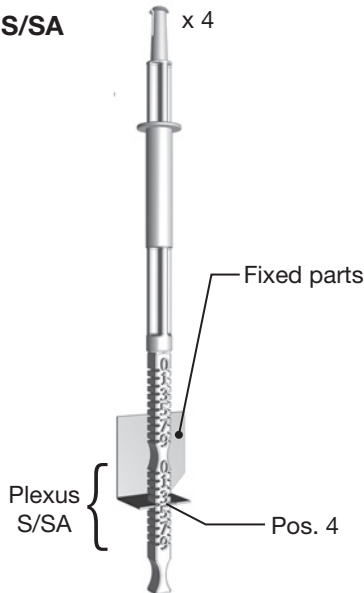

Plexus L, M, H

x 4

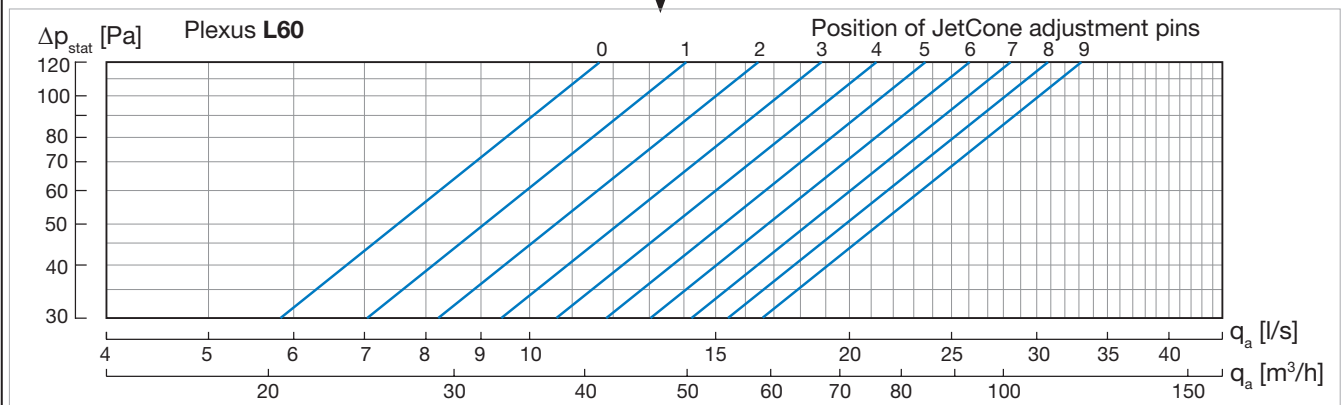
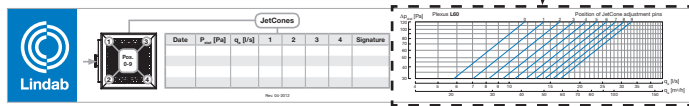
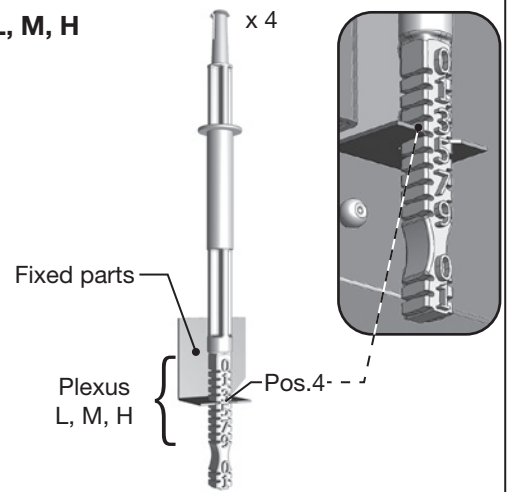

Quick Installation Guide

Plexus

Measuring static nozzle pressure

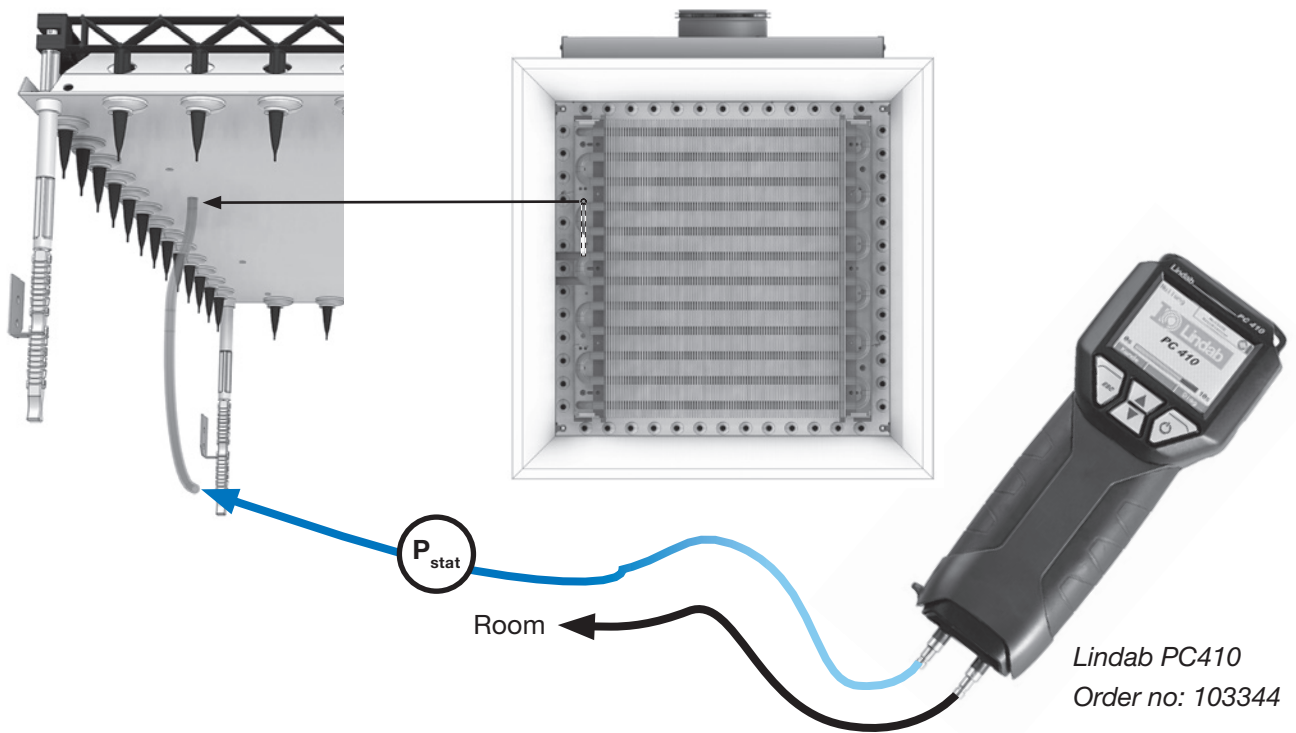

Maintenance

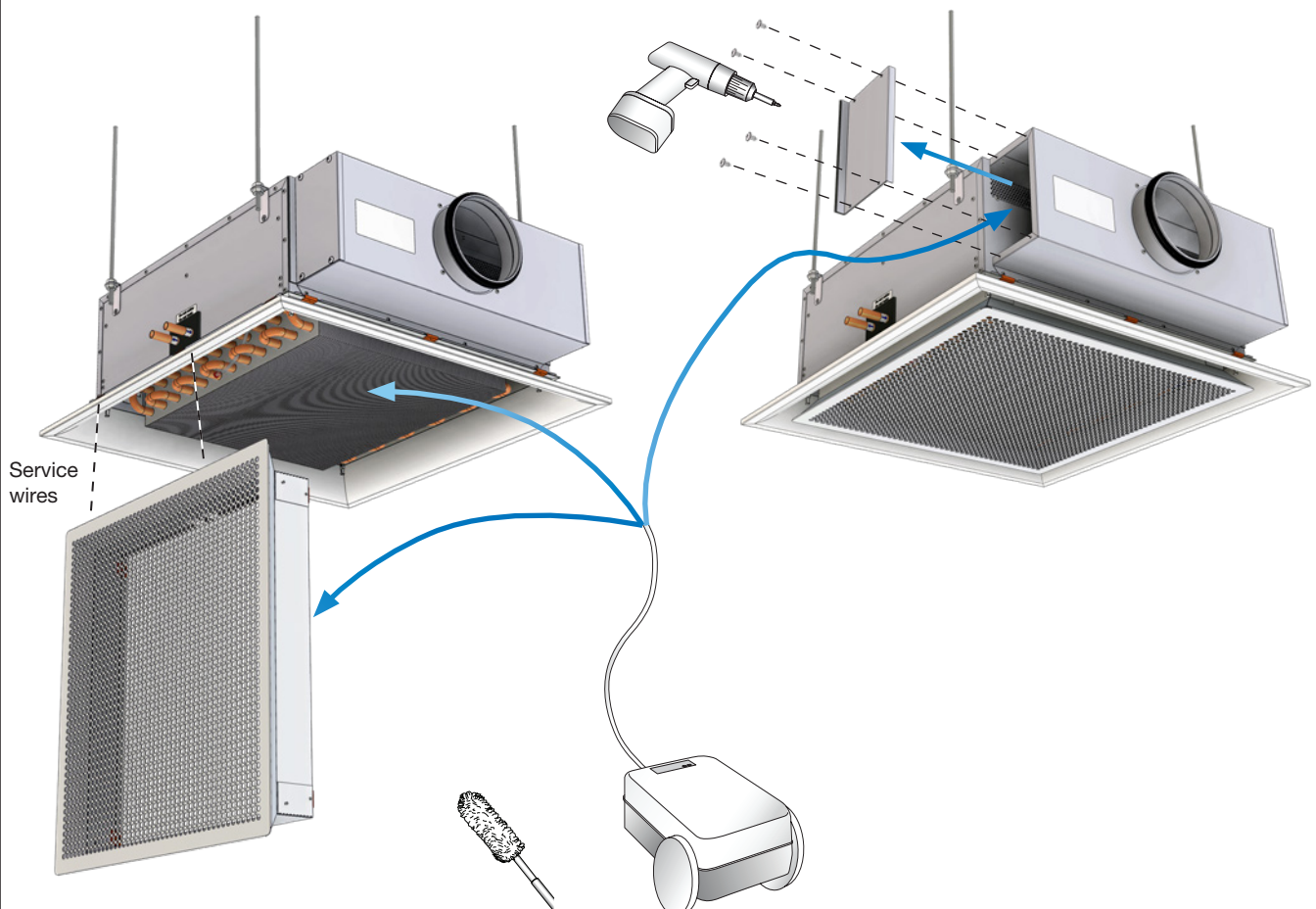



Most of us spend the majority of our time indoors. Indoor climate is crucial to how we feel, how productive we are and if we stay healthy.

We at Lindab have therefore made it our most important objective to contribute to an indoor climate that improves people's lives. We do this by developing energy-efficient ventilation solutions and durable building products. We also aim to contribute to a better climate for our planet by working in a way that is sustainable for both people and the environment.

[Lindab](#) | For a better climate