



# Lindab **Stainless Duct System**

Technical information



## Content

Stainless duct system .....	3
Products .....	3
The circular duct system .....	3
The rectangular duct system .....	3
Description .....	3
Methods of use .....	3
The raw material .....	3
Corrosivity classes according to ISO 12944-2 with environmental examples .....	4
Eurovent certification .....	4
Product Overview .....	5
Ducts .....	5
Bends .....	6
Cleaning bends .....	14
Reducers .....	15
T-pieces .....	23
X-pieces .....	27
Take-offs .....	29
Couplings .....	32
End caps .....	34
Access doors .....	35
Dampers .....	36
Spjäll .....	37
UltraLink .....	39
Duct suspension and support system .....	40
Rectangular duct system .....	43
Fasteners .....	46
Other circular products .....	47

# Stainless duct system

## Products

The purpose of this brochure is to present which of Lindab's duct system products that are available in stainless steel. For more detailed information about the system and the products see our brochure "General information and theory" or each product's web page.

Products made of stainless steel are normally handmade instead of pressed and can therefore differ from the standard galvanized assortment in sizing and weight. Circular bends, 45° and 90°, in dimensions Ø100, Ø125 and Ø160 are exempted as they are pressed in both stainless and galvanized steel.

## The circular duct system

The circular system is part of the Lindab Safe range of products and is manufactured as standard with a double seal gasket made of EPDM rubber. Standard dimensions adapted to EN 1506 are manufactured with a turned-over edge, which provides very good structural stability and increased durability against damage caused through handling.

For substances that cannot be tolerated by gaskets made of EPDM rubber – see the table about how various substances affect the gasket on Lindab's web page on air duct systems under the section "Safe" – gaskets made of silicon rubber can be used instead. If this additional option is not possible, fittings without gaskets can be manufactured.

## The rectangular duct system

The rectangular system, which is part of the Lindab Rectangular range of products, consists of rectangular ducts and fittings with dimensions adapted to EN 1505 unless otherwise specified. The system is stable, homogeneous and torsional rigid thanks to reinforcement profiles and trapezoidal corrugated duct walls.

## Description

Stainless steel does not readily corrode, rust or stain with water as ordinary steel does. However, it is not fully stain-proof in low-oxygen, high-salinity, or poor air-circulation environments. There are different grades and surface finishes of stainless steel to suit the environment the alloy must endure. Stainless steel is used where both the properties of steel and corrosion resistance are required.

## Methods of use

Stainless steel is divided into two grades.

- The lowest grade is according to EN 1.4301 (AISI 304) and complies with the requirements for corrosivity class C4, EN 1.4301, which is the most common grade of stainless steel with a range of uses including kitchen equipment, domestic appliances, other purposes for indoor use and for slightly corrosive outdoor atmospheres, consists of approximately 9% nickel, 18% chromium and the rest steel.
- The higher grade is according to EN 1.4404 (AISI 316L) and complies with the requirements for corrosivity class C5-I and C5-M, EN 1.4404, which is recommended for use in coastal areas and in polluted city or industrial atmospheres, consists of approximately 11% nickel, 17% chromium, 2.7% molybdenum and the rest steel. It is through the amalgamation with molybdenum that the improved corrosion properties are obtained.

Despite the fact that a lot of energy is consumed in the production of stainless steel, these materials are worthwhile from an environmental and cost perspective. The reason for this is that a large proportion of scrap is retrieved for amalgamation. That in many cases surface treatment is not necessary and that the need for maintenance decreases as the service life of the constructions increases.

## The raw material

Ducts and fittings are manufactured as standard from bright annealed (BA) stainless steel sheets according to EN 1.4301 (EN 1.4501, AISI 304) and EN 1.4404 (AISI 316L). These grades have a very bright and even surface with a finish that is aesthetically pleasing.

# Stainless duct system

## Corrosivity classes according to ISO 12944-2 with environmental examples

Corrosivity category	Corrosivity	Examples of typical environments (informative only)	
		Exterior	Interior
C1	Very low	-	Heated buildings with clean atmosphere, e.g. offices, shops, schools, hotels.
C2	Low	Atmospheres with low level of pollution: mostly rural areas.	Unheated buildings where condensation can occur, e.g. depots, sports halls.
C3	Medium	Urban and industrial atmospheres. moderate sulfur dioxide pollution; coastal areas with low salinity.	Production rooms with high humidity and some air pollution, e.g. food-processing plants, laundries, breweries, dairies.
C4	High	Industrial areas and coastal areas with moderate salinity.	Chemical plants, swimming pools, coastal ship and boatyards.
C5	Very high	Industrial areas with high humidity and aggressive atmosphere and coastal areas with high salinity.	Buildings or areas with almost permanent condensation and with high pollution.
CX	Extreme	Offshore areas with high salinity and industrial areas with extreme humidity and aggressive atmosphere and subtropical and tropical atmospheres.	Industrial areas with extreme humidity and aggressive atmosphere.

## Eurovent certification

Lindab's circular duct system with rubber gasket connections Lindab Safe and Lindab Safe Click is certified to strength and leakage in tightness class D according to the Eurovent Certified Performance program for circular metallic ducts systems (DUCT-MC). Check ongoing validity of certificate:



[www.eurovent-certification.com](http://www.eurovent-certification.com)

The purpose of Eurovent third party Certification is to create a common set of criteria to all relevant features for the rating of products in this system and ensure the constancy of performance over time.

Through specification of products in Lindab's certified system. Lindab Safe and Lindab Safe Click, the engineer's tasks become easier, since there is no need to carry out detailed comparison and performance qualification testing. Consultants, specifiers and users can select products with the assurance that the catalogue data are accurate to a certain level.

Lindab products that are Eurovent certified have the Eurovent logotype in the footer of the technical documentation.

Note: Most Lindab Safe and Lindab Safe Click and the most commonly used product in a ventilation system are essentially better than class D, however some products are according to EN 15727 not class D as a single product. These products are stated in the documentation as Class C and can be used in D class systems to a limited extension.

# Product Overview

## Circular duct system

# Ducts

### SR. circular duct

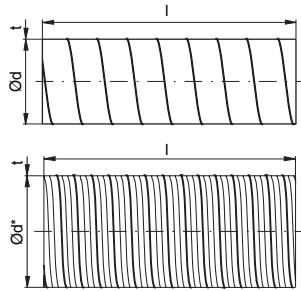

Ød nom	t mm	m kg/m	Comment
63	0.5	0.89	
80	0.5	1.01	
100	0.5	1.27	
112	0.5	1.42	
125	0.5	1.57	
140	0.5	1.76	
150	0.5	1.89	
160	0.5	2.02	
180	0.5	2.26	
200	0.5	2.56	
224	0.5	2.87	
250	0.5	3.18	
280	0.5	3.56	
300	0.5	3.82	
315	0.5	4.01	
355	0.5	4.51	
400	0.5	5.46	
450	0.6	7.37	
500	0.6	8.18	
560	0.6	9.20	
600	0.6	9.80	
630	0.6	10.3	
710	0.8	15.5	
800	0.8	17.4	
900	0.8	19.3	
1000	0.8	21.4	
1120	0.8	24.0	
1250	0.8	26.8	

For more detailed information about technical data and measures see datasheet for [SR](#)



# Circular duct system

# Bends

## BU 90° pressed bend

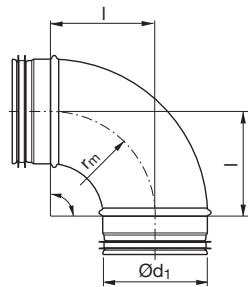

Ød, nom	Comment
100	For more detailed information about technical data and measures see datasheet for <a href="#">BU 90°</a>
125	
160	

Are only availabel in EN 1.4404.

## BU 45° pressed bend

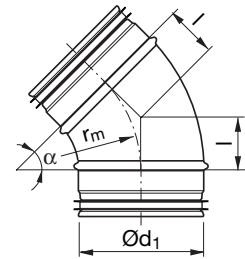

Ød, nom	Comment
100	For more detailed information about technical data and measures see datasheet for <a href="#">BU 45°</a>
125	
160	

Are only availabel in EN 1.4404.

# Circular duct system

# Bends

## BFU 90°. lockseamed bend

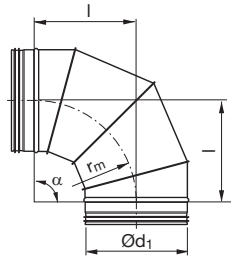

## Technical data

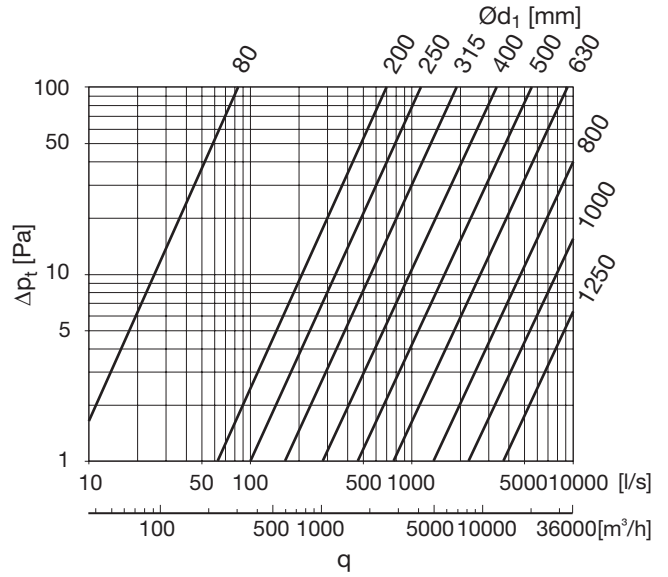

Ød, nom	l mm	m kg
80	80	0.25
140	140	0.61
150	150	0.84
180	180	1.02
200	200	1.30
224	224	1.33
250	•	•
280	•	•
300	•	•
315	•	•
355	•	•
400	•	•
450	•	•
500	•	•
560	•	•
600	•	•
630	•	•
710	•	•
800	•	•
900	•	•
1000	•	•
1120	•	•
1250	•	•

- For more detailed information about measures see datasheet for [BFU 90°](#)



# Circular duct system

# Bends

## BFU 45° lockseamed bend

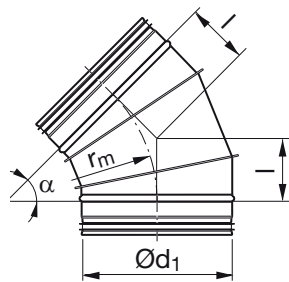

Ød, nom	l mm	m kg
80	33	0.17
140	58	0.42
150	62	0.47
180	75	0.64
200	83	0.80
224	93	0.82
250	•	•
280	•	•
300	•	•
315	•	•
355	•	•
400	•	•
450	•	•
500	•	•
560	•	•
600	•	•
630	•	•
710	•	•
800	•	•
900	•	•
1000	•	•
1120	•	•
1250	•	•

## Technical data

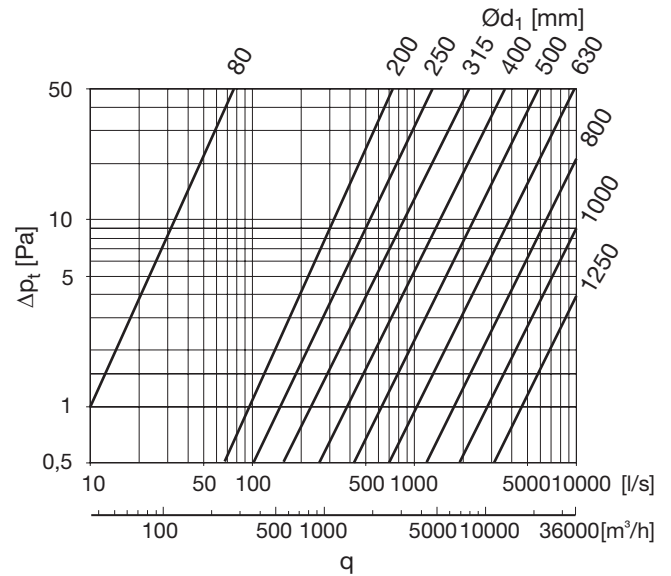

- For more detailed information about measures see datasheet for [BFU 45°](#)



# Circular duct system

# Bends

## BFU 60°. lockseamed bend

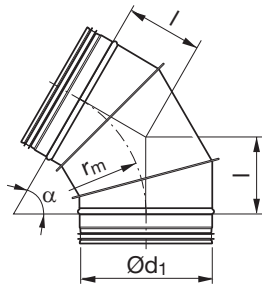

## Technical data

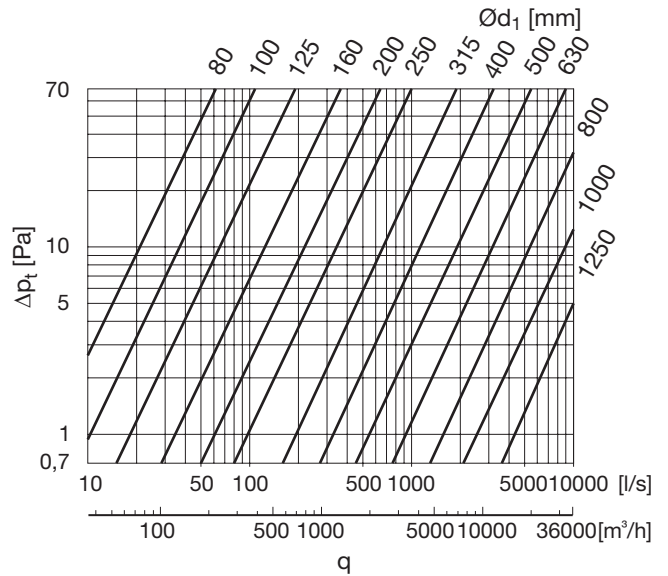

Ød, nom	l mm	m kg
80	46	0.24
100	58	0.33
125	72	0.40
140	81	0.50
150	87	0.58
160	104	0.65
180	92	0.79
200	115	0.95
224	129	0.99
250	•	•
280	•	•
300	•	•
315	•	•
355	•	•
400	•	•
450	•	•
500	•	•
560	•	•
600	•	•
630	•	•
710	•	•
800	•	•
900	•	•
1000	•	•
1120	•	•
1250	•	•

- For more detailed information about technical data and measures see datasheet for [BFU 60°](#)



# Circular duct system

# Bends

## BFU 30° lockseamed bend

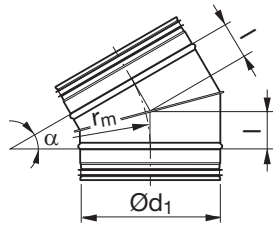

Ød <sub>1</sub> nom	l mm	m kg
80	21	0.16
100	27	0.17
125	34	0.24
140	38	0.30
150	40	0.36
160	48	0.43
180	43	0.51
200	54	0.62
224	60	0.72
250	•	•
280	•	•
300	•	•
315	•	•
355	•	•
400	•	•
450	•	•
500	•	•
560	•	•
600	•	•
630	•	•
710	•	•
800	•	•
900	•	•
1000	•	•
1120	•	•
1250	•	•

## Technical data

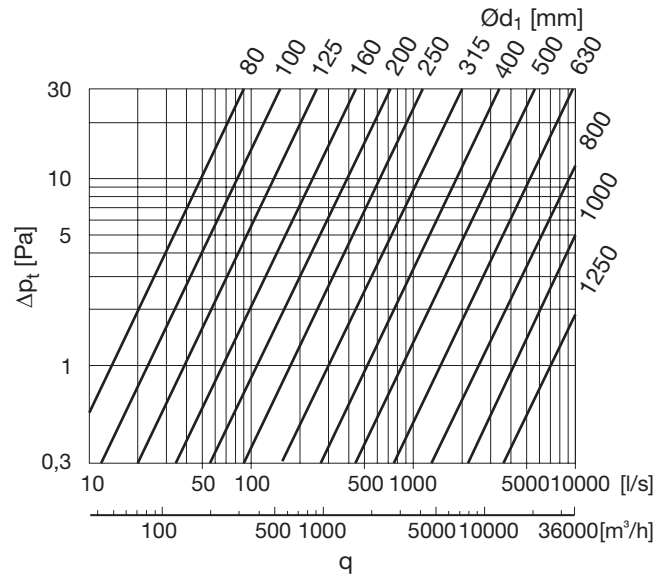

- For more detailed information about technical data and measures see datasheet for [BFU 30°](#)

## Circular duct system

## Bends

## BFU 15° lockseamed bend

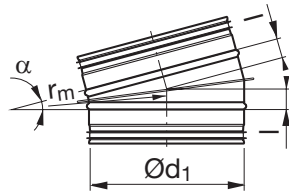

Ød, nom	l mm	m kg
80	11	0.15
100	13	0.15
125	17	0.20
140	18	0.25
150	20	0.31
160	24	0.40
180	21	0.50
200	26	0.60
224	30	0.66
250	•	•
280	•	•
300	•	•
315	•	•
355	•	•
400	•	•
450	•	•
500	•	•
560	•	•
600	•	•
630	•	•
710	•	•
800	•	•
900	•	•
1000	•	•
1120	•	•
1250	•	•

- For more detailed information about technical data and measures see datasheet for [BFU 15°](#)

## Technical data

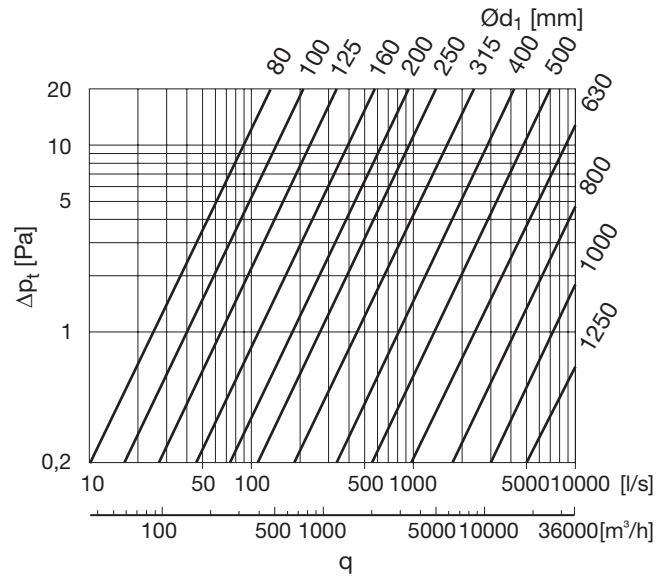

# Circular duct system

# Bends

## BKU 90° short bend

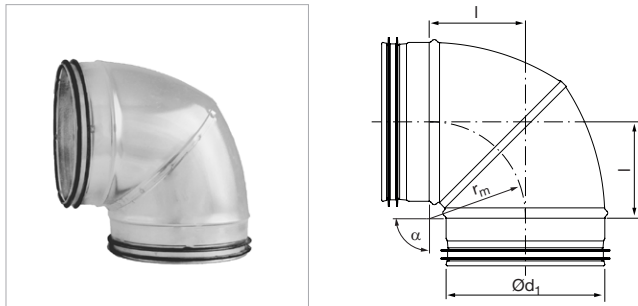

Ød, nom	l mm	m kg
80 *	55	0.14
100	62	0.24
125	79	0.36
160	94	0.53

\* Elliptical design

- For more detailed information about technical data and measures see datasheet for [BKU 90°](#)

## BKMU 90° short bend with female end

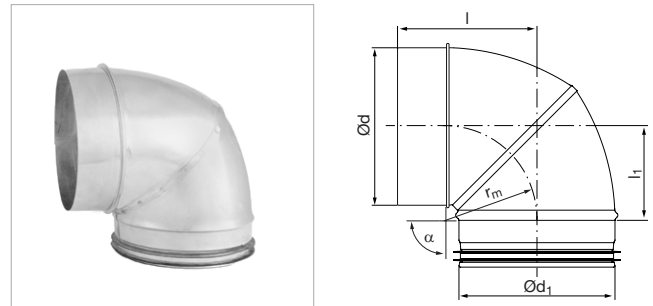

Ød, nom	l mm	l1 mm	m kg
80 *	97	55	0.13
100	105	65	0.25
125	120	79	0.48
160	137	94	0.86

\* Elliptical design

- For more detailed information about technical data and measures see datasheet for [BKMU 90°](#)

## BKFU 90° short lockseamed bend

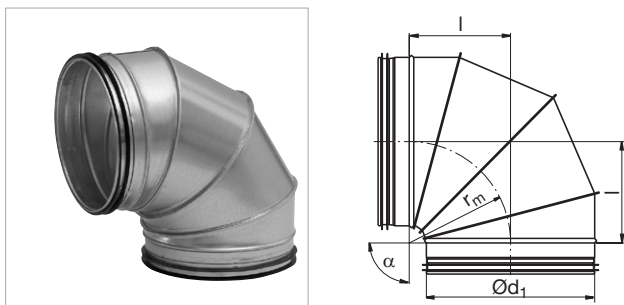

Ød, nom	Comment
200	For more detailed information about technical data and measures see datasheet for <a href="#">BKFU 90°</a>
250	
315	
355	
400	
500	
630	
710	
800	
1000	
1120	
1250	

## BKFMU 90° short segmented bend with female end

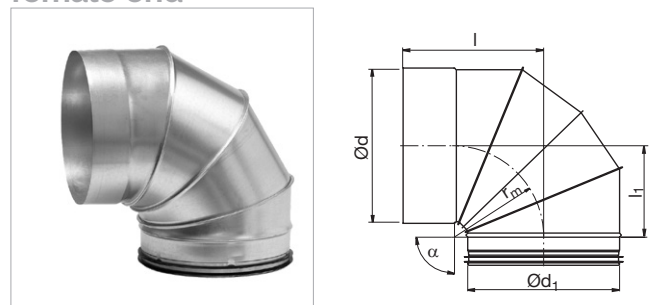

Ød, nom	Comment
200	For more detailed information about technical data and measures see datasheet for <a href="#">BKFMU 90°</a>
250	
315	
400	
500	
630	
710	
800	
1000	
1120	
1250	

# Circular duct system

# Bends

**BSFU 90°. long. lockseamed bend**

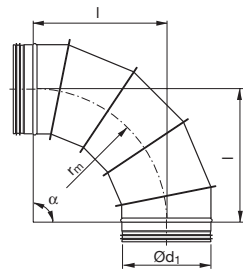

**BSFU 45°. long. lockseamed bend**

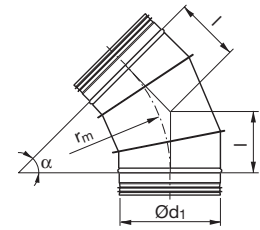

Ød, nom	Comment
250	
280	
300	
315	
355	
400	
450	
500	
560	For more detailed information about technical data and measures see datasheet for <a href="#">BSFU 90°</a>
600	
630	
710	
800	
900	
1000	
1120	
1250	

Ød, nom	Comment
250	
280	
300	
315	
355	
400	
450	
500	
560	For more detailed information about technical data and measures see datasheet for <a href="#">BSFU 45°</a>
600	
630	
710	
800	
900	
1000	
1120	
1250	

# Circular duct system

# Cleaning bends

## BKCU 90° cleaning bend

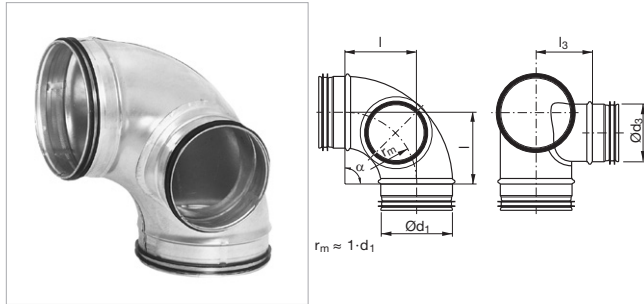

Ød <sub>1</sub> nom	Ød <sub>3</sub>		
	100	125	160
100	•		
125	•	•	
160		•	•

**Comment:** For more detailed information about technical data and measures see datasheet for [BKCU 90°](#)

- Available dimensions

Are only available in EN 1.4404.

## BBKCU 90° cleaning bend

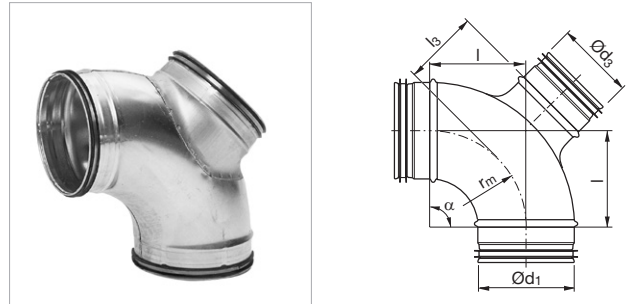

Ød <sub>1</sub> nom	Ød <sub>3</sub>		
	100	125	160
100	•		
125	•	•	
160		•	•

**Comment:** For more detailed information about technical data and measures see datasheet for [BBKCU 90°](#)

- Available dimensions

Are only available in EN 1.4404.

## BFKCU 90° cleaning bend

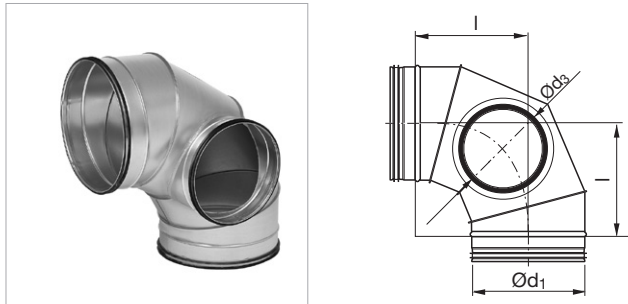

Ød <sub>1</sub> nom	Ød <sub>3</sub>						
	100	125	160	200	250	315	400
112	•						
140		•					
150		•					
180			•				
200			•				
224				•			
250				•	•		
300					•		
315					•	•	
400						•	•

**Comment:** For more detailed information about technical data and measures see datasheet for [BFKCU 90°](#)

- Available dimensions

## BFBKCU 90° cleaning bend

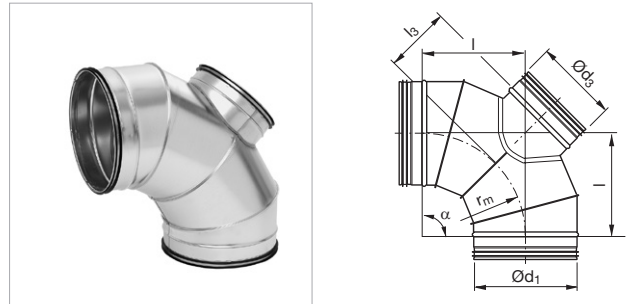

Ød <sub>1</sub> nom	Ød <sub>3</sub>						
	100	125	160	200	250	315	400
112	•						
140		•					
150		•					
180			•				
200			•				
224				•			
250				•	•		
300					•		
315					•	•	
400						•	•

**Comment:** For more detailed information about technical data and measures see datasheet for [BFBKCU 90°](#)

- Available dimensions



# Circular duct system

# Reducers

## RCU. reducer

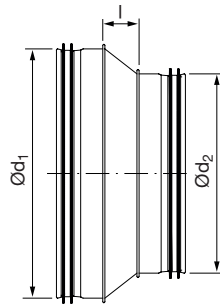

Ød <sub>1</sub> nom	Ød <sub>2</sub>												
	63	80	100	125	150	160	180	200	224	250	315	400	500
80	•												
100	•	•											
125		•	•										
150			•	•									
160		•	•	•	•								
180			•	•	•	•							
200			•	•	•	•	•						
224					•	•	•	•					
250				•	•	•	•	•	•				
300								•		•			
315						•		•		•			
355										•	•		
400								•		•	•		
500										•	•	•	
630											•	•	•

**Comment:** For more detailed information about technical data and measures see datasheet for [RCU](#)

- Available dimensions

# Circular duct system

# Reducers

## RCFU. reducer with female end

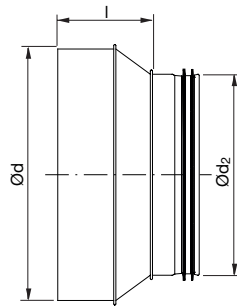

Ød nom	Ød <sub>2</sub>												
	63	80	100	125	150	160	180	200	224	250	315	400	500
80	•												
100	•	•											
125		•	•										
150			•	•									
160			•	•	•								
180			•	•	•	•							
200			•	•	•	•	•						
224					•	•	•	•					
250				•	•	•	•	•	•				
300								•		•			
315						•		•		•			
355										•	•		
400								•		•	•		
500										•	•	•	
630											•	•	•

**Comment:** For more detailed information about technical data and measures see datasheet for [RCFU](#)

- Available dimensions



# Circular duct system

# Reducers

## RU. eccentric reducer

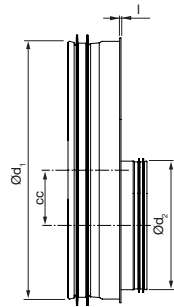

Ød <sub>1</sub> nom	Ød <sub>2</sub>																		
	200	224	250	280	300	315	355	400	450	500	560	600	630	710	800	900	1000	1120	
400	•	•	•	•	•	•	•												
450			•	•	•	•	•	•											
500			•	•	•	•	•	•	•										
560						•	•	•	•	•									
600						•	•	•	•	•	•								
630						•	•	•	•	•	•	•							
710								•	•	•	•	•	•						
800								•	•	•	•	•	•	•					
900										•	•	•	•	•	•				
1000										•	•	•	•	•	•	•			
1120													•	•	•	•	•		
1250													•	•	•	•	•	•	•

**Comment:** For more detailed information about technical data and measures see datasheet for [RU](#)

- Available dimensions



# Circular duct system

# Reducers

## RFU. eccentric reducer with female end

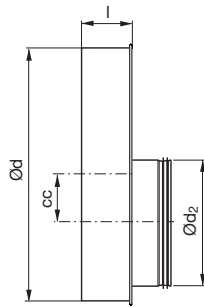

Ød nom	Ød <sub>2</sub>																	
	200	224	250	280	300	315	355	400	450	500	560	600	630	710	800	900	1000	1120
400	•	•	•	•	•	•	•											
450			•	•	•	•	•	•										
500			•	•	•	•	•	•	•									
560						•	•	•	•	•								
600						•	•	•	•	•	•							
630						•	•	•	•	•	•	•						
710								•	•	•	•	•	•					
800								•	•	•	•	•	•	•				
900										•	•	•	•	•	•			
1000										•	•	•	•	•	•	•		
1120													•	•	•	•	•	
1250													•	•	•	•	•	•

**Comment:** For more detailed information about technical data and measures see datasheet for [RFU](#)

- Available dimensions

# Circular duct system

# Reducers

RFLU. long. tangential reducer with female end

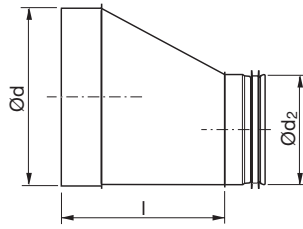

Ød nom	Ød <sub>2</sub>																											
	63	80	100	112	125	140	150	160	180	200	224	250	280	300	315	355	400	450	500	560	600	630	710	800	900	1000	1120	
80	•																											
100	•	•																										
112	•	•	•																									
125	•	•		•																								
140	•	•		•	•																							
150	•	•	•	•	•	•																						
160	•	•	•	•	•	•	•																					
180		•	•	•	•	•	•	•																				
200		•	•	•	•	•	•	•	•																			
224			•	•	•	•	•	•	•	•																		
250			•	•	•	•	•	•	•	•	•																	
280					•	•	•	•	•	•	•	•																
300					•	•	•	•	•	•	•	•	•															
315					•	•	•	•	•	•	•	•	•	•														
355								•	•	•	•	•	•	•	•													
400								•	•	•	•	•	•	•	•	•												
450										•	•	•	•	•	•	•	•											
500										•	•	•	•	•	•	•	•	•										
560											•	•	•	•	•	•	•	•	•									
600											•	•	•	•	•	•	•	•	•	•								
630											•	•	•	•	•	•	•	•	•	•	•							
710															•	•	•	•	•	•	•	•	•					
800																	•	•	•	•	•	•	•	•	•			
900																		•	•	•	•	•	•	•	•	•		
1000																			•	•	•	•	•	•	•	•	•	
1120																				•	•	•	•	•	•	•	•	
1250																					•	•	•	•	•	•	•	•

**Comment:** For more detailed information about technical data and measures see datasheet for [RFLU](#)

- Available dimensions



# Circular duct system

# Reducers

## RCLU. long. concentric reducer

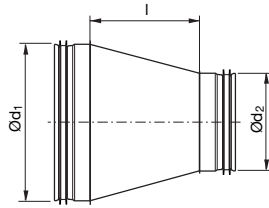

Ød <sub>1</sub> nom	Ød <sub>2</sub>																											
	63	80	100	112	125	140	150	160	180	200	224	250	280	300	315	355	400	450	500	560	600	630	710	800	900	1000	1120	
112	•	•	•																									
125	•			•																								
140	•	•	•	•	•																							
150	•	•		•		•																						
160	•			•		•																						
180		•		•		•																						
200		•		•		•																						
224			•	•	•	•																						
250			•	•		•																						
280					•	•	•	•	•	•	•	•																
300					•	•	•	•	•		•		•															
315					•	•	•		•		•		•	•														
355								•	•	•	•	•	•	•														
400								•	•		•		•	•		•												
450										•	•	•	•	•	•	•	•											
500										•	•	•	•	•	•	•	•	•										
560												•	•	•	•	•	•	•	•	•								
600												•	•	•	•	•	•	•	•	•	•							
630												•	•	•		•	•	•	•	•	•	•						
710																•	•	•	•	•	•	•	•					
800																	•	•	•	•	•	•	•	•	•			
900																		•	•	•	•	•	•	•	•	•		
1000																			•	•	•	•	•	•	•	•	•	
1120																				•	•	•	•	•	•	•	•	
1250																					•	•	•	•	•	•	•	•

**Comment:** For more detailed information about technical data and measures see datasheet for [RCLU](#)

- Available dimensions



# Circular duct system

# Reducers

RCFLU. long. concentric reducer with female end

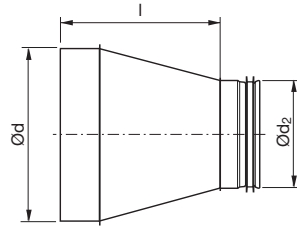

Ød nom	Ød <sub>2</sub>																											
	63	80	100	112	125	140	150	160	180	200	224	250	280	300	315	355	400	450	500	560	600	630	710	800	900	1000	1120	
80	•																											
100	•	•																										
112	•	•	•																									
125	•	•	•	•																								
140	•	•	•	•	•																							
150	•	•	•	•	•	•																						
160	•	•	•	•	•	•	•																					
180		•	•	•	•	•	•	•																				
200		•	•	•	•	•	•	•	•																			
224			•	•	•	•	•	•	•	•																		
250			•	•	•	•	•	•	•	•	•																	
280					•	•	•	•	•	•	•	•																
300					•	•	•	•	•	•	•	•	•															
315					•	•	•	•	•	•	•	•	•	•														
355								•	•	•	•	•	•	•	•													
400								•	•	•	•	•	•	•	•	•												
450										•	•	•	•	•	•	•	•											
500										•	•	•	•	•	•	•	•	•										
560											•	•	•	•	•	•	•	•	•									
600												•	•	•	•	•	•	•	•	•								
630												•	•	•	•	•	•	•	•	•	•							
710																•	•	•	•	•	•	•						
800																	•	•	•	•	•	•	•	•				
900																		•	•	•	•	•	•	•	•	•		
1000																			•	•	•	•	•	•	•	•	•	
1120																				•	•	•	•	•	•	•	•	
1250																					•	•	•	•	•	•	•	•

**Comment:** For more detailed information about technical data and measures see datasheet for [RCFLU](#)

- Available dimensions



# Circular duct system

# Reducers

## RLU. long tangential reducer

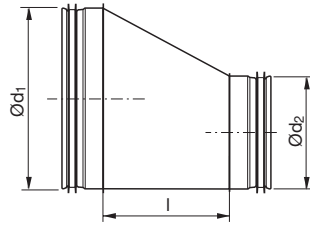

Ød <sub>1</sub> nom	Ød <sub>2</sub>																											
	63	80	100	112	125	140	150	160	180	200	224	250	280	300	315	355	400	450	500	560	600	630	710	800	900	1000	1120	
80	•																											
100	•	•																										
112	•	•	•																									
125	•	•	•	•																								
140	•	•	•	•	•																							
150	•	•	•	•	•	•																						
160	•	•	•	•	•	•	•																					
180		•	•	•	•	•	•	•																				
200		•	•	•	•	•	•	•	•																			
224			•	•	•	•	•	•	•	•																		
250			•	•	•	•	•	•	•	•	•																	
280					•	•	•	•	•	•	•	•																
300					•	•	•	•	•	•	•	•	•															
315					•	•	•	•	•	•	•	•	•	•														
355								•	•	•	•	•	•	•	•													
400								•	•	•	•	•	•	•	•	•												
450										•	•	•	•	•	•	•	•											
500										•	•	•	•	•	•	•	•	•										
560											•	•	•	•	•	•	•	•	•									
600												•	•	•	•	•	•	•	•	•								
630												•	•	•	•	•	•	•	•	•	•							
710																•	•	•	•	•	•	•						
800																	•	•	•	•	•	•	•	•				
900																		•	•	•	•	•	•	•	•	•		
1000																			•	•	•	•	•	•	•	•	•	
1120																				•	•	•	•	•	•	•	•	•
1250																					•	•	•	•	•	•	•	•

**Comment:** For more detailed information about technical data and measures see datasheet for [RLU](#)

- Available dimensions



# Circular duct system

# T-pieces

## TCU. centric T-piece

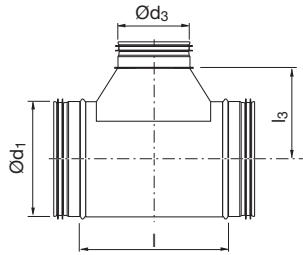

Ød <sub>1</sub> nom	Ød <sub>3</sub>																											
	63	80	100	112	125	140	150	160	180	200	224	250	280	300	315	355	400	450	500	560	600	630	710	800	900	1000	1120	1250
63	•*	•	•																									
80	•*	•*		•	•																							
100	•*	•*	•*	•	•	•	•	•																				
112	•*	•*	•*	•		•	•	•	•																			
125	•*	•*	•*	•*	•*	•	•	•	•	•																		
140	•	•*	•*	•*	•	•*	•	•	•	•	•																	
150	•	•*	•*	•	•*	•*	•*	•*		•	•	•																
160	•	•*	•*		•*	•*	•*	•*		•	•	•																
180	•	•*	•*	•	•*	•*	•*	•*	•*	•	•	•	•															
200	•	•*	•*	•	•*	•*	•*	•*	•*	•*	•	•	•	•														
224	•	•*	•*	•	•*	•*	•*	•*	•*	•*	•*	•	•	•	•													
250	•	•*	•*	•	•*	•*	•*	•*	•*	•*	•*	•*	•	•	•	•	•											
280		•*	•*	•	•*	•*	•*	•*	•*	•*	•*	•	•	•	•	•	•	•										
300				•								•	•		•	•	•	•										
315		•*	•*	•	•*			•*		•*		•*			•*	•	•	•	•	•								
355				•								•	•		•	•	•	•	•	•								
400			•*	•	•*	•	•	•*	•	•*	•*	•*	•	•	•*	•	•*	•	•	•	•	•	•	•	•	•	•	•
450			•*		•*	•	•	•*	•	•*	•*	•*	•	•*	•*	•*	•*	•	•	•	•	•	•	•	•	•	•	•
500			•*		•*	•	•	•*	•	•*	•	•*	•	•*	•*	•*	•*	•	•	•	•	•	•	•	•	•	•	•
560			•*		•*			•*		•*	•	•*	•	•*	•*	•*	•*	•	•	•	•	•	•	•	•	•	•	•
600			•*		•*			•*		•*	•	•*	•	•*	•*	•*	•*	•	•	•	•	•	•	•	•	•	•	•
630			•*		•*			•*		•*	•	•*	•	•*	•*	•*	•*	•	•	•	•	•	•	•	•	•	•	•
710												•	•	•	•	•	•	•	•	•	•	•	•	•	•	•	•	•
800												•	•	•	•	•	•	•	•	•	•	•	•	•	•	•	•	•
900															•	•	•	•	•	•	•	•	•	•	•	•	•	•
1000															•	•	•	•	•	•	•	•	•	•	•	•	•	•
1120																			•	•	•	•	•	•	•	•	•	•
1250																			•	•	•	•	•	•	•	•	•	•

**Comment:** For more detailed information about technical data and measures see datasheet for [TCU](#)

- Available dimensions
- \* Only available in stainless steel. When made in galvanized this dimension is pressed. see [TCPU](#)



# Circular duct system

# T-pieces

## TU. tangential T-piece

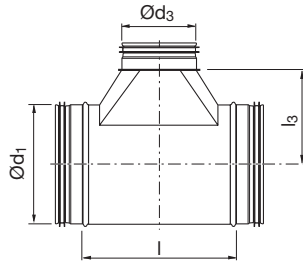

Ød <sub>1</sub> nom	Ød <sub>3</sub>																											
	63	80	100	112	125	140	150	160	180	200	224	250	280	300	315	355	400	450	500	560	600	630	710	800	900	1000	1120	1250
63	•	•	•																									
80	•	•	•	•	•																							
100	•	•	•	•	•	•	•	•																				
112	•	•	•	•	•	•	•	•	•																			
125	•	•	•	•	•	•	•	•	•	•																		
140	•	•	•	•	•	•	•	•	•	•	•																	
150	•	•	•	•	•	•	•	•	•	•	•	•																
160	•	•	•	•	•	•	•	•	•	•	•	•																
180	•	•	•	•	•	•	•	•	•	•	•	•	•															
200	•	•	•	•	•	•	•	•	•	•	•	•	•	•	•													
224	•	•	•	•	•	•	•	•	•	•	•	•	•	•	•	•												
250	•	•	•	•	•	•	•	•	•	•	•	•	•	•	•	•	•											
280		•	•	•	•	•	•	•	•	•	•	•	•	•	•	•	•	•										
300		•	•	•	•	•	•	•	•	•	•	•	•	•	•	•	•	•	•									
315		•	•	•	•	•	•	•	•	•	•	•	•	•	•	•	•	•	•	•								
355			•	•	•	•	•	•	•	•	•	•	•	•	•	•	•	•	•	•	•							
400			•	•	•	•	•	•	•	•	•	•	•	•	•	•	•	•	•	•	•	•						
450				•	•	•	•	•	•	•	•	•	•	•	•	•	•	•	•	•	•	•	•					
500					•	•	•	•	•	•	•	•	•	•	•	•	•	•	•	•	•	•	•	•				
560										•	•	•	•	•	•	•	•	•	•	•	•	•	•	•	•			
600										•	•	•	•	•	•	•	•	•	•	•	•	•	•	•	•	•		
630										•	•	•	•	•	•	•	•	•	•	•	•	•	•	•	•	•	•	
710												•	•	•	•	•	•	•	•	•	•	•	•	•	•	•	•	•
800												•	•	•	•	•	•	•	•	•	•	•	•	•	•	•	•	•
900															•	•	•	•	•	•	•	•	•	•	•	•	•	•
1000															•	•	•	•	•	•	•	•	•	•	•	•	•	•
1120																					•	•	•	•	•	•	•	•
1250																					•	•	•	•	•	•	•	•

**Comment:** For more detailed information about technical data and measures see datasheet for [TU](#)

- Available dimensions





# Circular duct system

# T-pieces

## TSTCU. centric T-piece

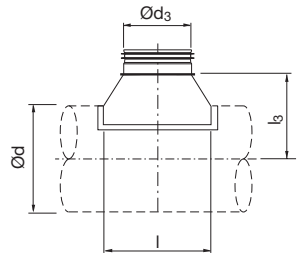

Ød nom	Ød <sub>3</sub>																												
	63	80	100	112	125	140	150	160	180	200	224	250	280	300	315	355	400	450	500	560	600	630	710	800	900	1000	1120	1250	
63		•	•																										
80		•*	•	•	•																								
100		•*	•*	•	•	•	•	•																					
112				•	•	•	•	•	•																				
125		•*	•*	•	•*	•	•	•	•	•																			
140		•		•			•	•	•	•	•																		
150		•		•			•	•	•	•	•	•																	
160	•	•*	•*	•	•*			•*	•	•	•	•																	
180	•	•		•	•	•	•	•		•	•	•	•																
200	•	•*	•*	•	•*			•*		•*	•	•	•	•	•														
224	•			•								•	•	•	•	•													
250	•		•*	•	•*			•*		•*		•*	•	•	•	•	•	•											
280				•								•	•	•	•	•	•	•											
300				•								•			•	•	•	•											
315		•*	•*	•	•*			•*		•*		•*	•		•*	•	•	•	•										
355				•								•			•	•	•	•	•	•									
400			•*	•	•*	•		•*	•	•*		•*	•		•*	•	•*	•	•	•	•	•	•						
450						•			•				•			•		•	•	•	•	•	•	•					
500						•			•				•			•		•	•	•	•	•	•	•	•				
560												•			•		•	•	•	•	•	•	•	•	•				
600												•			•		•	•	•	•	•	•	•	•	•	•			
630												•			•		•	•	•	•	•	•	•	•	•	•			
710												•	•	•	•	•	•	•	•	•	•	•	•	•	•	•	•	•	
800												•	•	•	•	•	•	•	•	•	•	•	•	•	•	•	•	•	•
900															•	•	•	•	•	•	•	•	•	•	•	•	•	•	•
1000															•	•	•	•	•	•	•	•	•	•	•	•	•	•	•
1120																			•	•	•	•	•	•	•	•	•	•	•
1250																			•	•	•	•	•	•	•	•	•	•	•

**Comment:** For more detailed information about technical data and measures see datasheet for [TSTCU](#)

- Available dimensions
- \* Only available in stainless steel. When made in galvanized this dimension is pressed. see [TCPU](#)



# Circular duct system

# T-pieces

## TSTU. tangential T-piece

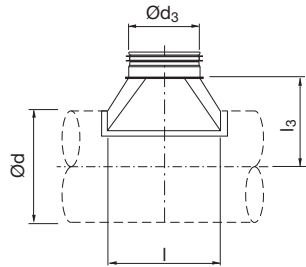

Ød nom	Ød <sub>3</sub>																											
	63	80	100	112	125	140	150	160	180	200	224	250	280	300	315	355	400	450	500	560	600	630	710	800	900	1000	1120	1250
63		•	•																									
80	•		•	•	•																							
100	•	•		•	•	•	•	•																				
112	•	•	•		•	•	•	•	•																			
125	•	•	•	•		•	•	•	•	•																		
140	•	•	•	•	•		•	•	•	•	•																	
150	•	•	•	•	•	•		•	•	•	•	•																
160	•	•	•	•	•	•	•		•	•	•	•																
180	•	•	•	•	•	•	•	•		•	•	•	•															
200	•	•	•	•	•	•	•	•	•		•	•	•	•	•													
224	•	•	•	•	•	•	•	•	•	•		•	•	•	•	•												
250	•	•	•	•	•	•	•	•	•	•	•		•	•	•	•	•											
280		•	•	•	•	•	•	•	•	•	•	•		•	•	•	•	•										
300		•	•	•	•	•	•	•	•	•	•	•	•		•	•	•	•	•									
315		•	•	•	•	•	•	•	•	•	•	•	•	•		•	•	•	•	•								
355			•	•	•	•	•	•	•	•	•	•	•	•	•		•	•	•	•	•							
400			•	•	•	•	•	•	•	•	•	•	•	•	•	•		•	•	•	•	•						
450				•	•	•	•	•	•	•	•	•	•	•	•	•	•		•	•	•	•	•	•				
500					•	•	•	•	•	•	•	•	•	•	•	•	•	•		•	•	•	•	•	•			
560										•	•	•	•	•	•	•	•	•	•		•	•	•	•	•	•		
600										•	•	•	•	•	•	•	•	•	•	•		•	•	•	•	•		
630										•	•	•	•	•	•	•	•	•	•	•	•		•	•	•	•	•	
710											•	•	•	•	•	•	•	•	•	•	•		•	•	•	•	•	
800											•	•	•	•	•	•	•	•	•	•	•	•		•	•	•	•	
900												•	•	•	•	•	•	•	•	•	•	•	•		•	•	•	
1000													•	•	•	•	•	•	•	•	•	•	•		•	•	•	
1120																				•	•	•	•	•	•	•	•	
1250																					•	•	•	•	•	•	•	

**Comment:** For more detailed information about technical data and measures see datasheet for [TSTU](#).

- Available dimensions



# Circular duct system

# X-pieces

## XCU. centric X-piece

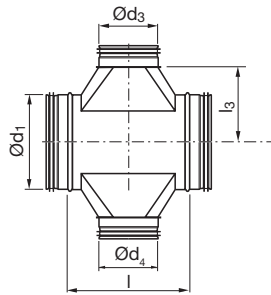
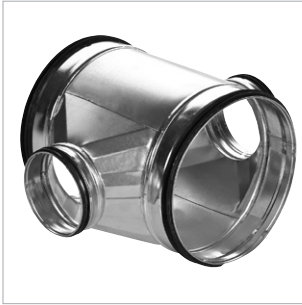

$\varnothing d_1$ nom	$\varnothing d_3 \varnothing d_4$																												
	63	80	100	112	125	140	150	160	180	200	224	250	280	300	315	355	400	450	500	560	600	630	710	800	900	1000	1120	1250	
63	•																												
80	•	•																											
100	•	•	•																										
112	•	•	•	•																									
125	•	•	•	•	•																								
140	•	•	•	•	•	•																							
150	•	•	•	•	•	•	•																						
160	•	•	•	•	•	•	•	•																					
180	•	•	•	•	•	•	•	•	•																				
200	•	•	•	•	•	•	•	•	•	•																			
224	•	•	•	•	•	•	•	•	•	•	•																		
250	•	•	•	•	•	•	•	•	•	•	•	•																	
280		•	•	•	•	•	•	•	•	•	•	•	•																
300		•	•	•	•	•	•	•	•	•	•	•	•	•															
315		•	•	•	•	•	•	•	•	•	•	•	•	•	•														
355			•	•	•	•	•	•	•	•	•	•	•	•	•	•													
400			•	•	•	•	•	•	•	•	•	•	•	•	•	•	•												
450				•	•	•	•	•	•	•	•	•	•	•	•	•	•	•											
500					•	•	•	•	•	•	•	•	•	•	•	•	•	•	•										
560																													
600																													
630																													
710																													
800																													
900																													
1000																													
1120																													
1250																													

**Comment:** For more detailed information about technical data and measures see datasheet for [XCU](#).

- Available dimensions



# Circular duct system

# X-pieces

## XU. tangential X-piece

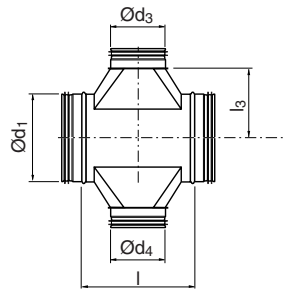

Ød <sub>1</sub> nom	Ød <sub>3</sub> Ød <sub>4</sub>																										
	63	80	100	112	125	140	150	160	180	200	224	250	280	300	315	355	400	450	500	560	600	630	710	800	900	1000	1120
80	•																										
100	•	•																									
112	•	•	•																								
125	•	•	•	•																							
140	•	•	•	•	•																						
150	•	•	•	•	•	•																					
160	•	•	•	•	•	•	•																				
180	•	•	•	•	•	•	•	•																			
200	•	•	•	•	•	•	•	•	•																		
224	•	•	•	•	•	•	•	•	•	•																	
250	•	•	•	•	•	•	•	•	•	•	•																
280		•	•	•	•	•	•	•	•	•	•	•															
300		•	•	•	•	•	•	•	•	•	•	•	•														
315		•	•	•	•	•	•	•	•	•	•	•	•	•													
355			•	•	•	•	•	•	•	•	•	•	•	•	•												
400			•	•	•	•	•	•	•	•	•	•	•	•	•	•											
450					•	•	•	•	•	•	•	•	•	•	•	•	•										
500					•	•	•	•	•	•	•	•	•	•	•	•	•	•									
560										•	•	•	•	•	•	•	•	•	•								
600										•	•	•	•	•	•	•	•	•	•	•							
630										•	•	•	•	•	•	•	•	•	•	•	•						
710												•	•	•	•	•	•	•	•	•	•	•					
800												•	•	•	•	•	•	•	•	•	•	•	•				
900														•	•	•	•	•	•	•	•	•	•	•			
1000															•	•	•	•	•	•	•	•	•	•	•	•	
1120																			•	•	•	•	•	•	•	•	•
1250																			•	•	•	•	•	•	•	•	•

**Comment:** For more detailed information about technical data and measures see datasheet for [XU](#).

- Available dimensions



# Circular duct system

# Take-offs

## ILU. take-off without radius

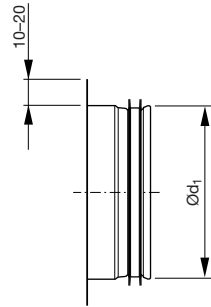

## ILF. take-off without radius with female end

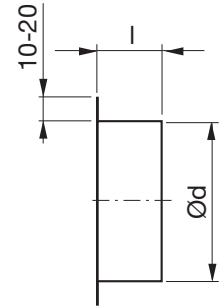

Ød, nom	Comment
63	
80	
100	
112	
125	
140	
150	
160	
180	
200	
224	
250	
280	
300	For more detailed information about technical data and measures see datasheet for <a href="#">ILU</a> .
315	
355	
400	
450	
500	
560	
600	
630	
710	
800	
900	
1000	
1120	
1250	

Ød nom	Comment
63	
80	
100	
112	
125	
140	
150	
160	
180	
200	
224	
250	
280	
300	For more detailed information about technical data and measures see datasheet for <a href="#">ILF</a> .
315	
355	
400	
450	
500	
560	
600	
630	
710	
800	
900	
1000	
1120	
1250	

# Circular duct system

# Take-offs

## ESNU. take-off with mesh

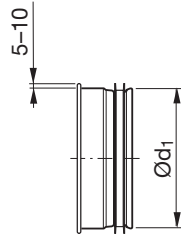

## EPNF. take-off with mesh and female end

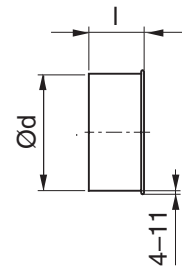

Ød, nom	Comment
63	
80	
100	
112	
125	
140	
150	
160	
180	
200	
224	
250	
280	
300	For more detailed information about technical data and measures see datasheet for <a href="#">ESNU</a> .
315	
355	
400	
450	
500	
560	
600	
630	
710	
800	
900	
1000	
1120	
1250	

Ød nom	Comment
63	
80	
100	
112	
125	
140	
150	
160	
180	
200	
224	
250	
280	
300	For more detailed information about technical data and measures see datasheet for <a href="#">EPNF</a> .
315	
355	
400	
450	
500	
560	
600	
630	
710	
800	
900	
1000	
1120	
1250	

# Circular duct system

# Take-offs

## ILKNU 50. take-off with mesh and cone

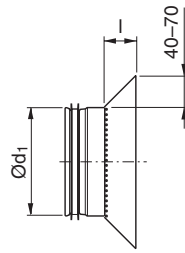

## ILKNU 100. take-off with mesh and cone

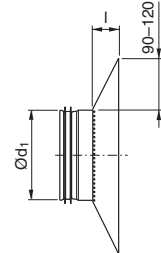

Ød, nom	Comment
80	For more detailed information about technical data and measures see datasheet for <a href="#">ILKNU 50.</a>
100	
125	
160	
200	
250	
315	
400	
500	
630	
800	

Ød, nom	Comment
80	For more detailed information about technical data and measures see datasheet for <a href="#">ILKNU 100.</a>
100	
125	
160	
200	
250	
315	
400	
500	
630	
800	

## ILKNF 50. take-off with mesh. cone and female end

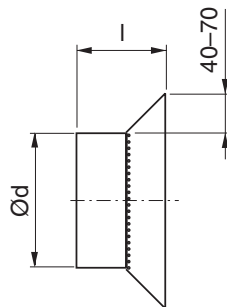

## ILKNF 100. take-off with mesh. cone and female end

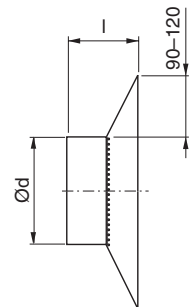

Ød, nom	Comment
100	For more detailed information about technical data and measures see datasheet for <a href="#">ILKNF 50.</a>
125	
160	
200	
250	
315	
400	
500	
630	
800	

Ød, nom	Comment
100	For more detailed information about technical data and measures see datasheet for <a href="#">ILKNF 100.</a>
125	
160	
200	
250	
315	
400	
500	
630	
800	

# Circular duct system

# Couplings

## NPU. coupling

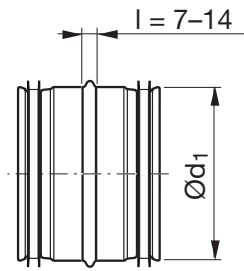

## SNPU. slide-in coupling

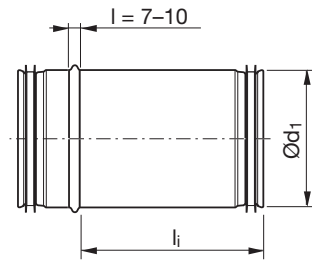

Ød, nom	Comment
63	
80	
100	
112	
125	
140	
150	
160	
180	
200	
224	
250	
280	
300	
315	
355	
400	
450	
500	
560	
600	
630	
710	
800	
900	
1000	
1120	
1250	

For more detailed information about technical data and measures see datasheet for [NPU](#).

Ød, nom	Comment
80	
100	
112	
125	
140	
150	
160	
180	
200	
224	
250	
280	
300	
315	
355	
400	
450	
500	
560	
630	
800	
1000	
1250	

All dimensions available in nominal lengths 150 mm, 300 mm and 500 mm.

For more detailed information about technical data and measures see datasheet for [SNPU](#).



# Circular duct system

# Couplings

## MF. female coupling

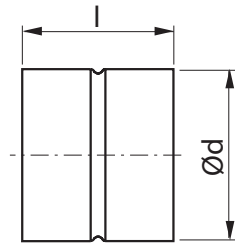
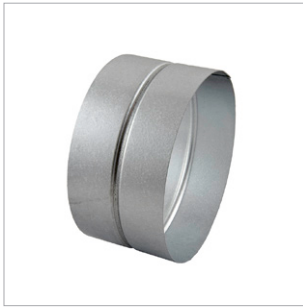

## SMFU. slide-in female coupling

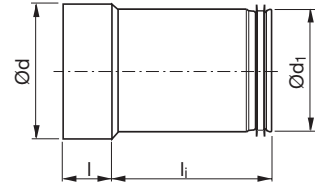

Ød nom	Comment
63	
80	
100	
112	
125	
140	
150	
160	
180	
200	
224	
250	
280	
300	
315	
355	
400	
450	
500	
560	
600	
630	
710	
800	
900	
1000	
1120	
1250	

For more detailed information about technical data and measures see datasheet for [MF](#).

Ød <sub>1</sub> nom	l mm	Comment
80		
100		
112		
125		
140		
150		
160		
180		
200		
224		
250		
280		
300		
315		
355		
400		
450		
500		
560		
630		
800		
1000		
1250		

150. 300 or 500

300 or 500

500

For more detailed information about technical data and measures see datasheet for [SMFU](#).

# Circular duct system

# End caps

## EPF. end cap

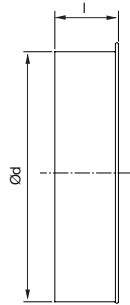

## ESU. end cap

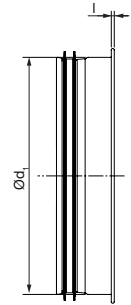

Ød nom	Comment
63	
80	
100	
112	
125	
140	
150	
160	
180	
200	
224	
250	
280	
300	For more detailed information about technical data and measures see datasheet for <a href="#">EPF</a> .
315	
355	
400	
450	
500	
560	
600	
630	
710	
800	
900	
1000	
1120	
1250	

Ød, nom	Comment
63	
80	
100	
112	
125	
140	
150	
160	
180	
200	
224	
250	
280	
300	For more detailed information about technical data and measures see datasheet for <a href="#">ESU</a> .
315	
355	
400	
450	
500	
560	
600	
630	
710	
800	
900	
1000	
1120	
1250	

# Circular duct system

# Access doors

## EPFH. access door

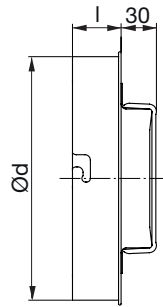

## ESHU. access door

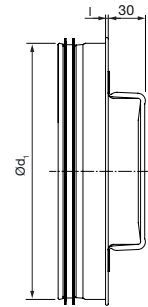

Ød nom	Comment
80	
100	
112	
125	
140	
150	
160	
180	
200	
224	
250	
280	
300	
315	
355	
400	
450	
500	
630	

For more detailed information about technical data and measures see datasheet for [EPFH](#).

Ød, nom	Comment
100	
112	
125	
140	
150	
160	
180	
200	
224	
250	
280	
300	
315	
355	
400	
450	
500	
630	

For more detailed information about technical data and measures see datasheet for [ESHU](#).

# Circular duct system

# Access doors

## KCU. insulated access door

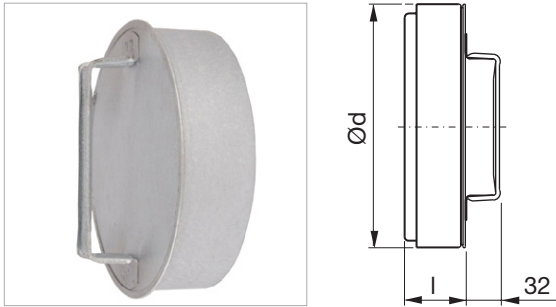

Ød nom	l	Insulation thickness	Comment
100	58	50	For more detailed information about technical data and measures see datasheet for <a href="#">KCU</a> .
125	58	50	
160	58	50	
200	58	50	
250	58	50	
315	58	50	
400	94	50	
500	94	50	
630	94	50	

# Circular duct system

# Dampers

## DRU. regulating damper

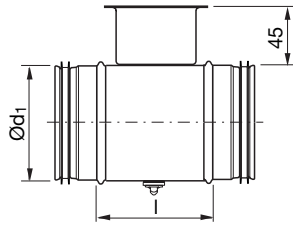

## DSU. shut-off damper

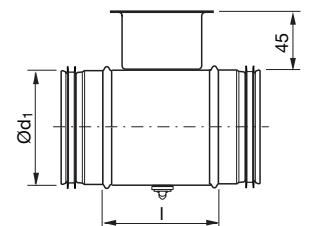

Ød, nom	Comment
80	
100	
112	
125	
140	
150	
160	
180	
200	
224	For more detailed information about technical data and measures see datasheet for <a href="#">DRU</a> .
250	
280	
300	
315	
355	
400	
450	
500	
560	
600	
630	

Ød, nom	Comment
63	
80	
100	
112	
125	
140	
150	
160	
180	
200	For more detailed information about technical data and measures see datasheet for <a href="#">DSU</a> .
224	
250	
280	
300	
315	
355	
400	
450	
500	
560	
600	
630	

# Circular duct system

# Dampers

## DTU. shut-off damper

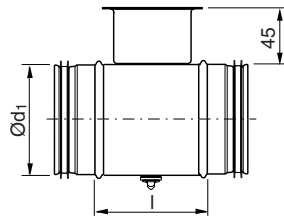

## DTHU. shut-off damper with motor shelf

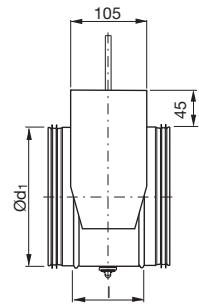

Ød, nom	Comment
80	
100	
112	
125	
140	
150	
160	
180	
200	
224	
250	For more detailed information about technical data and measures see datasheet for <a href="#">DTU</a> .
280	
300	
315	
355	
400	
450	
500	
560	
600	
630	

Ød, nom	Comment
80	
100	
112	
125	
140	
150	
160	
180	
200	
224	
250	For more detailed information about technical data and measures see datasheet for <a href="#">DTHU</a> .
280	
300	
315	
355	
400	
450	
500	
560	
600	
630	
800	
1000	

# Circular duct system

# UltraLink

## FTCU. UltraLink Controller

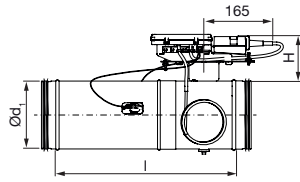

## FTMU. UltraLink Monitor

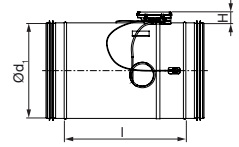

Ød, nom	Comment
100	For more detailed information about technical data and measures see datasheet for <a href="#">FTCU</a> .
125	
160	
200	
250	
315	

Ød, nom	Comment
100	For more detailed information about technical data and measures see datasheet for <a href="#">FTMU</a> .
125	
160	
200	
250	
315	
400	
500	
630	

# Duct suspension and support system

## MDH. duct holder

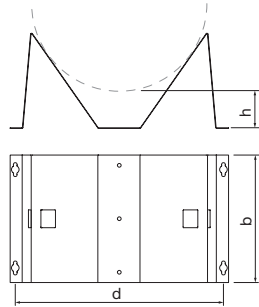

Ød nom	Comment
100	
112	
125	
140	
150	
160	
180	
200	
224	
250	
280	
300	
315	For more detailed information about technical data and measures see datasheet for <a href="#">MDH</a> .
355	
400	
450	
500	
560	
600	
630	
710	
800	
900	
1000	
1120	
1250	

## DH. duct holder

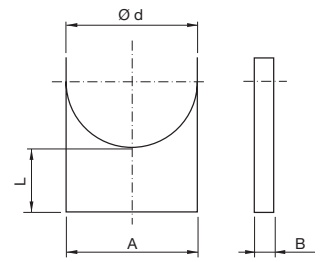

Ød nom	Comment
63	
80	
100	
125	
160	For more detailed information about technical data and measures see datasheet for <a href="#">DH</a> .
200	
250	
315	
400	
500	
630	

## FB 30. suspension band

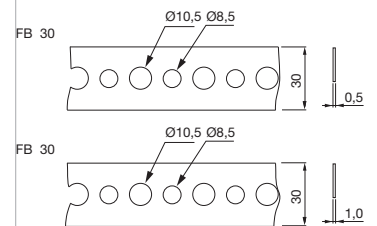

Width mm	Thickness mm	Length m	Comment
30	0.5	25	For more detailed information about technical data and measures see datasheet for <a href="#">FB 30</a>
30	1.0	25	

Are only available in EN 1.4301.



# Duct suspension and support system

## UV30. suspension rings

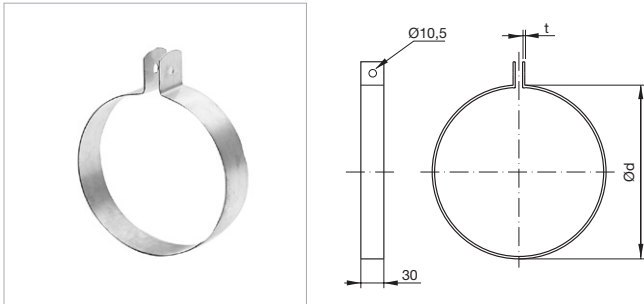

## UV25. suspension rings

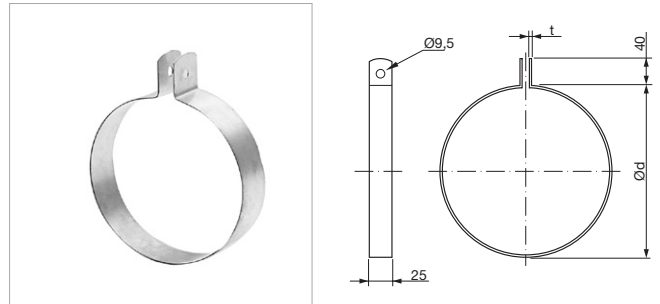

Ød nom	Comment
80	
100	
112	
125	
140	
150	
160	
175	
180	
200	
224	
250	
260	
280	
300	
315	
350	
355	
400	
415	
450	
500	
560	
600	
630	
710	
800	
850	
900	
1000	
1120	
1250	

For more detailed information about technical data and measures see datasheet for [UV30](#).

Ød nom	Comment
80	
100	
112	
125	
140	
150	
160	
175	
180	
200	
224	
250	
260	
280	
300	
315	
350	
355	
400	
415	
450	
500	
560	
600	
630	
710	
800	
850	
900	
1000	
1120	
1250	

For more detailed information about technical data and measures see datasheet for [UV25](#).

Are only available in EN 1.4404.

Are only available in EN 1.4404.

# Duct suspension and support system

## UVH30. suspension rings

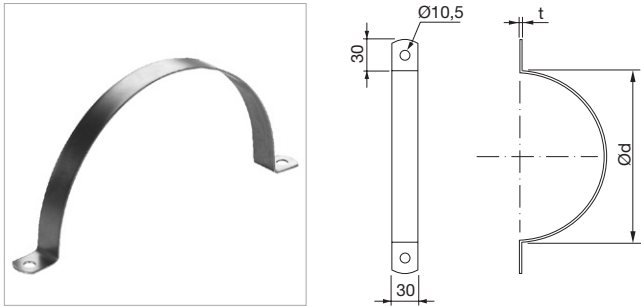

Ød nom	Comment
80	
100	
112	
125	
140	
150	
160	
175	
180	
200	
224	
250	
260	
280	
300	
315	
350	
355	
400	
415	
450	
500	
560	
600	
630	
710	
800	
850	
900	
1000	
1120	
1250	
1400	
1500	
1600	

For more detailed information about technical data and measures see datasheet for [UVH30](#).

Are only available in EN 1.4404.

# Rectangular duct system

## LKR. duct

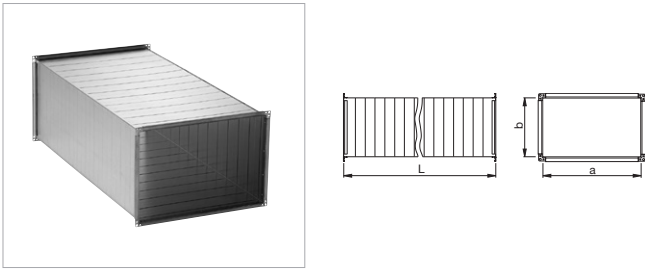

**Comment**

For more detailed information about technical data and measures see datasheet for [LKR](#).

## LBR. bend (90° and 45°)

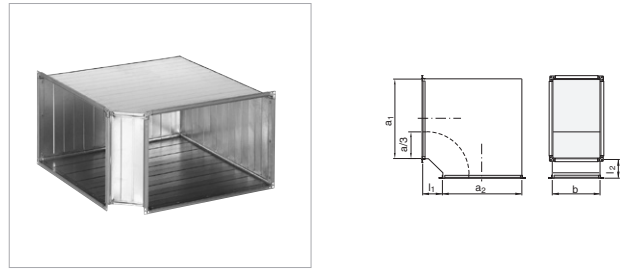

**Comment**

For more detailed information about technical data and measures see datasheet for [LBR](#).

## LBXR. bend (90° and 45°)

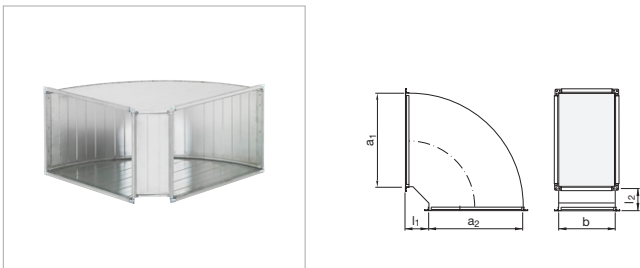

**Comment**

For more detailed information about technical data and measures see datasheet for [LBXR](#).

## LBSR. s-bend

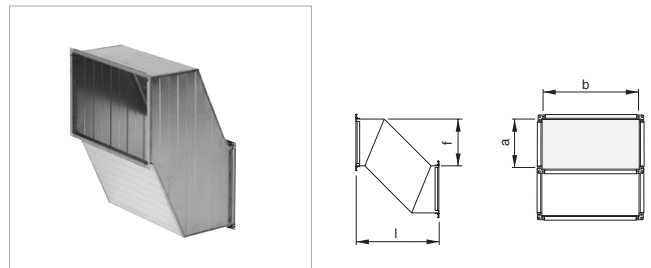

**Comment**

For more detailed information about technical data and measures see datasheet for [LBSR](#).

## LDR. taper

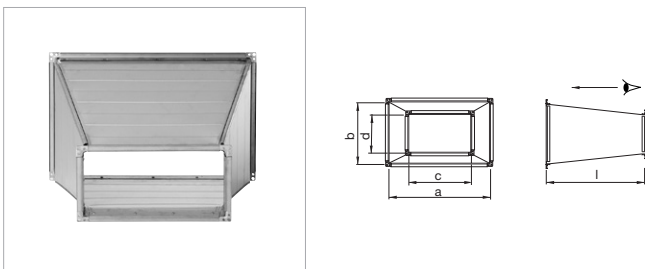

**Comment**

For more detailed information about technical data and measures see datasheet for [LDR](#).

## LORU. rect-to-round transition

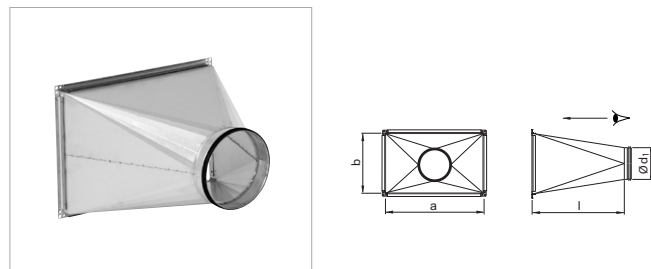

**Comment**

For more detailed information about technical data and measures see datasheet for [LORU](#).

# Rectangular duct system

## LAR. collar

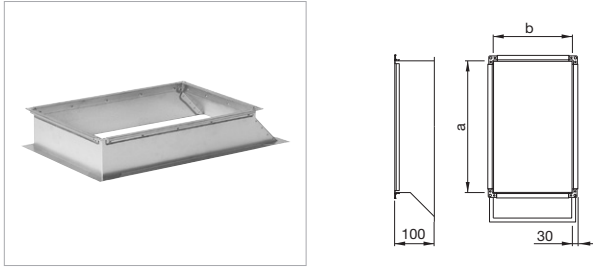

**Comment**

For more detailed information about technical data and measures see datasheet for [LAR](#).

## LTTR. T-piece

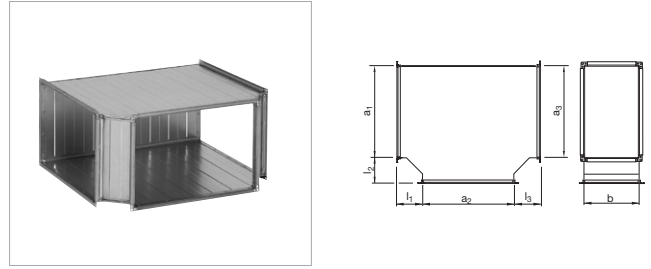

**Comment**

For more detailed information about technical data and measures see datasheet for [LTTR](#).

## LEPR. end cover

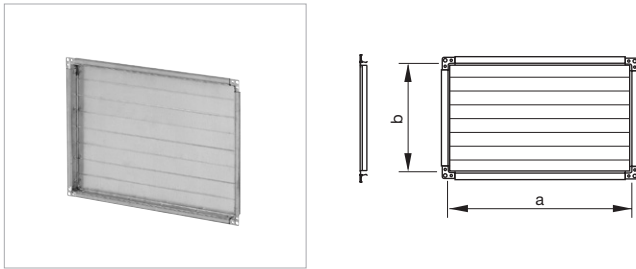

**Comment**

For more detailed information about technical data and measures see datasheet for [LEPR](#).

## LPSR. collar on circular duct

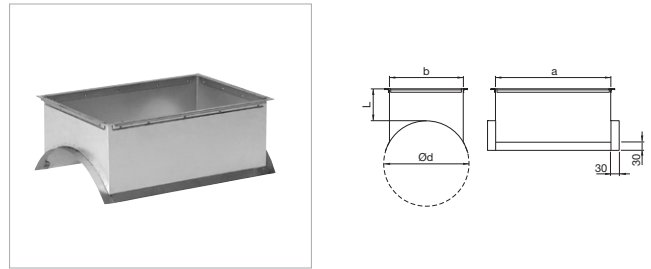

**Comment**

For more detailed information about technical data and measures see datasheet for [LPSR](#).

## RJFP. flange profiles



**Dim**

20

40

**Comment**

For more detailed information about technical data and measures see datasheet for [RJFP3C](#).

## RJBC. rectangular joint bolt clamp



**Comment**

For more detailed information about technical data and measures see datasheet for [RJBC](#).

Are only available in EN 1.4404.

Are only available in EN 1.4404.

# Rectangular duct system

## RJCL. corner



Dim	Comment
20	For more detailed information about technical data and measures see datasheet for <a href="#">RJCL</a> .
40	

Are only available in EN 1.4404.

## RJSP. rectangular joint slide profile



Comment
For more detailed information about technical data and measures see datasheet for <a href="#">RJSP</a> .

Are only available in EN 1.4404.

# Fasteners

## Drill screw. hexagon head



Type	Comment
TG10	For more detailed information about technical data and measures see technical information for <a href="#">TG</a>
TG12	

## Drill screw. convex head



Type	Comment
SH11	For more detailed information about technical data and measures see technical information for <a href="#">SH</a>
SH12	

## Blind rivet. pressure-tight

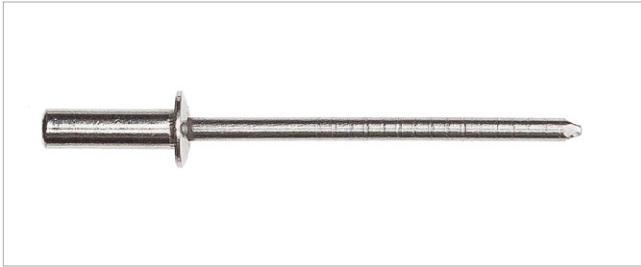

Type	Comment
RH13	For more detailed information about technical data and measures see technical information for <a href="#">RH</a>
RH22	
RH31	
RH33	

## Blind rivet. open



Type	Comment
RE12	For more detailed information about technical data and measures see technical information for <a href="#">RE</a>
RE13	
RE14	
RE22	
RE24	

# Other circular products

## FL 4404. Flange



Ød nom	Comment
100	
125	
140	
150	
160	
180	
200	
224	
250	
280	
300	
315	
355	
400	
450	
500	
560	
600	
630	
710	
800	
900	
1000	
1120	
1250	

For more detailed information about technical data and measures see datasheet for [FL 4404](#).



Most of us spend the majority of our time indoors. Indoor climate is crucial to how we feel, how productive we are and if we stay healthy.

We at Lindab have therefore made it our most important objective to contribute to an indoor climate that improves people's lives. We do this by developing energy-efficient ventilation solutions and durable building products. We also aim to contribute to a better climate for our planet by working in a way that is sustainable for both people and the environment.

[Lindab | For a better climate](#)