

Constant volume flow regulator MRP-6

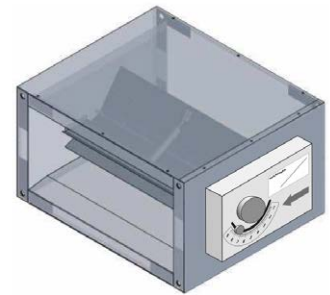
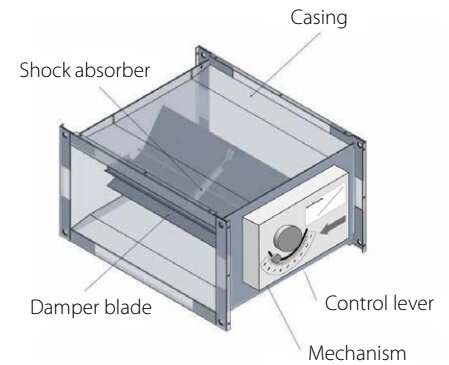
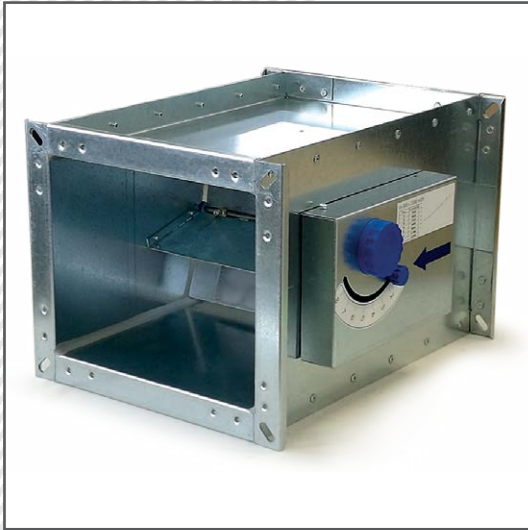

Constant volume flow regulators **MRP-6** and **MRP-6-I** are mechanical regulators used to maintain a constant volume flow rate independently of the pressure variations in ventilation and air conditioning systems. Regulators can be installed in a supply and extract air systems. Each regulator is set to the required flow rate and subjected to the aerodynamic function test conducted in our test facility.

The flow rate can be easily set or reset by adjusting the control lever on the calibrated scale. This is done by loosening the control lever's wing bolt and turning the control lever's arrow pointer to the desired value. When adjusted, the control lever is fixed by tightening the wing bolt.

Regulators work at the differential pressure range from 50 to 1000 Pa and the air velocity range from 3 to 10 m/s. As a reference value, recommended air velocity is around 6,5 m/s, where the accuracy of a constant flow rate is usually within a tolerance from $\pm 5\%$ of the set value.

The regulator can operate, without the direct influence of weather conditions on the operation, within a temperature range of $-20\text{ }^{\circ}\text{C}$ up to $80\text{ }^{\circ}\text{C}$ and relative humidity up to 80 %.

Regulators should be stored in closed and dry places at temperatures from $-20\text{ }^{\circ}\text{C}$ to $+60\text{ }^{\circ}\text{C}$.

Regulator versions:

MRP-6 – Constant volume flow regulator, rectangular

MRP-6-I – Constant volume flow regulator, rectangular - insulated

CASING – made of galvanised sheet steel

MECHANISM – control lever mechanism adjusts the spring tension to control the air flow

DAMPER BLADE – provides resistance to the air flow

SHOCK ABSORBER – serves to absorb the damper blade vibration caused by the air flow

INSULATION CLADDING – 30 mm mineral wool layer with galvanised sheet steel outer cover

Single controller

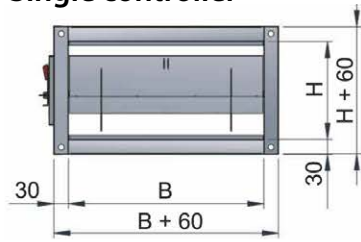

B \ H	150	200	250
150	✓	✓	✓
200	✓	✓	✓
250	✓	✓	✓
300	✓	✓	✓
350	✓	✓	✓
400	✓	✓	✓
450	✓	✓	✓
500	✗	✓	✓

Dual controller

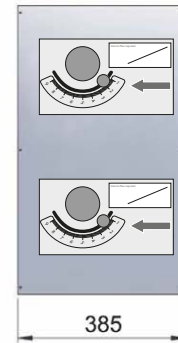
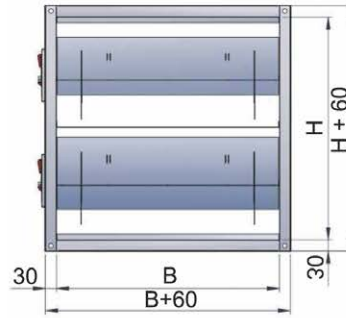
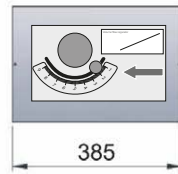

B \ H	400	450	500
400	✓	✓	✓
450	✓	✓	✓
500	✓	✓	✓

Quick selection diagram

B x H [mm]	Q [m³/h]																					
	200	300	400	500	600	700	800	900	1000	1200	1400	1600	1800	2000	2500	3000	3500	4000	5000	6000		
150x150		260					740															
200x150			400						960													
250x150			400								1200											
300x150					600									1800								
400x150					600										2100							
450x150						700										2500						
200x200					600							1400										
250x200					600								1700									
300x200						700								1800								
350x200							800										2500					
400x200								900										3300				
450x200									1000										3400			
500x200										1080												
550x200											1200											
600x200												900										4000
250x250					600												2190					
300x250							800											2600				
350x250								970											3200			
400x250									1080											3600		
450x250										1200												4000
500x250											1400											
550x250												1500										
600x250													1700									
300x300									900													2900
350x300										1100												3300
400x300											1300											3800
450x300												1500										
500x300														1900								4000
550x300															1900							4200
600x300																1900						4500
																						6100

Generated noise MRP-6

Model		$D_p = 125 \text{ Pa}$									$D_p = 250 \text{ Pa}$									$D_p = 500 \text{ Pa}$								
		Sound power level L_w [dB/(A)]									Sound power level L_w [dB/(A)]									Sound power level L_w [dB/(A)]								
$B \times H$ [mm]	Q [m ³ /h]	63 Hz	125 Hz	250 Hz	500 Hz	1000 Hz	2000 Hz	4000 Hz	8000 Hz	TOT Hz	63 Hz	125 Hz	250 Hz	500 Hz	1000 Hz	2000 Hz	4000 Hz	8000 Hz	TOT Hz	63 Hz	125 Hz	250 Hz	500 Hz	1000 Hz	2000 Hz	4000 Hz	8000 Hz	TOT Hz
600 x 300	1944	48	48	42	47	50	49	44	37	41	53	56	48	52	56	57	53	47	49	59	61	53	58	61	63	61	56	55
	3240	57	55	48	52	53	52	47	41	42	61	62	53	60	59	60	56	49	49	65	67	60	61	64	67	64	59	56
	5184	62	62	52	56	55	54	50	43	43	67	68	58	60	61	63	59	53	50	72	73	64	65	67	69	66	61	56
600 x 250	1620	47	48	40	44	48	47	43	36	39	54	58	47	51	56	55	52	47	46	56	61	50	55	58	61	59	55	53
	2700	55	55	46	48	51	50	47	39	40	60	62	51	54	57	57	55	49	48	64	68	56	58	62	64	62	57	54
	4320	62	61	51	53	53	52	49	43	42	68	68	57	58	60	60	58	52	49	72	74	62	62	65	67	66	61	56
600 x 200	1296	42	43	32	32	32	28	25	24	38	51	56	42	46	52	51	49	45	45	56	61	47	50	55	58	57	53	52
	2160	53	56	41	46	48	47	44	39	39	58	62	47	51	53	54	53	48	46	62	58	53	55	58	61	60	56	53
	3456	60	62	46	49	50	51	47	42	40	65	68	54	54	55	57	56	51	47	69	74	58	58	62	64	64	59	54
500 x 300	1620	51	48	43	48	51	50	46	38	43	57	54	49	54	57	58	54	48	49	61	59	55	58	62	64	61	57	56
	2700	59	55	49	52	54	53	48	42	44	64	62	56	58	60	61	58	51	52	68	66	61	62	65	68	64	59	57
	4320	65	61	54	55	56	56	51	45	45	71	66	60	61	62	63	59	54	52	74	72	65	66	67	71	69	63	58
500 x 250	1350	49	48	42	45	49	48	43	38	42	54	54	48	51	56	56	52	48	49	59	59	53	55	61	62	60	55	55
	2250	57	55	46	49	52	51	46	41	43	62	61	53	55	58	59	56	51	50	68	66	59	59	62	66	63	58	56
	3600	65	59	51	53	54	54	51	43	44	69	67	58	58	61	61	58	53	51	74	72	63	63	66	68	67	62	57
500 x 200	1080	49	47	38	42	46	45	42	36	40	53	53	45	47	52	54	51	45	48	58	59	49	52	57	59	58	55	54
	1800	56	55	44	46	49	48	46	39	41	62	60	49	51	55	56	54	49	48	65	66	56	56	61	63	62	57	55
	2880	63	61	48	50	51	51	48	43	42	68	66	55	54	57	59	57	52	49	72	72	61	59	62	65	64	59	56
400 x 300	1296	54	46	45	51	52	52	46	41	46	59	53	52	56	58	59	55	49	52	63	57	57	61	64	66	62	58	58
	2160	61	52	51	53	56	55	49	44	47	67	58	57	59	62	62	57	52	53	71	65	63	64	66	69	65	61	60
	3456	68	58	56	57	58	57	53	46	47	73	65	62	63	64	65	62	55	55	77	69	67	68	68	71	68	64	60



Generated noise MRP-6

Modell		$D_p = 125 \text{ Pa}$									$D_p = 250 \text{ Pa}$									$D_p = 500 \text{ Pa}$								
		Sound power level L [dB/(A)]									Sound power level L [dB/(A)]									Sound power level L [dB/(A)]								
$B \times H$ [mm]	Q [m ³ /h]	63 Hz	125 Hz	250 Hz	500 Hz	1000 Hz	2000 Hz	4000 Hz	8000 Hz	TOT Hz	63 Hz	125 Hz	250 Hz	500 Hz	1000 Hz	2000 Hz	4000 Hz	8000 Hz	TOT Hz	63 Hz	125 Hz	250 Hz	500 Hz	1000 Hz	2000 Hz	4000 Hz	8000 Hz	TOT Hz
400 x 250	1080	53	46	43	48	51	50	44	39	44	58	52	49	52	56	57	53	48	51	62	58	54	57	61	64	62	56	58
	1800	60	52	48	51	53	52	48	42	45	65	59	55	56	59	61	56	52	52	70	65	61	61	64	67	64	59	59
	2880	67	58	53	54	56	55	51	44	46	73	64	61	60	61	63	59	54	53	76	71	65	64	67	71	67	62	60
400 x 200	864	51	46	40	44	47	47	43	38	43	56	53	46	48	54	54	52	46	48	62	58	52	53	59	61	59	56	56
	1440	59	52	46	47	50	50	47	41	44	64	58	52	52	55	57	55	51	50	68	65	57	57	62	64	63	58	57
	2304	66	58	51	52	52	52	49	44	44	72	65	57	56	58	61	58	53	51	75	71	61	60	63	67	65	62	58
300 x 200	648	54	44	43	45	49	49	44	39	46	59	49	49	51	55	56	53	48	53	65	55	54	56	60	63	61	57	59
	1080	62	51	48	49	51	52	47	43	46	67	56	55	54	57	59	57	53	53	72	63	59	59	64	66	64	61	60
	1728	69	55	53	52	54	56	51	45	47	74	63	59	58	61	62	59	55	54	78	67	64	64	65	59	68	64	61
300 x 150	486	48	49	43	43	44	46	39	31	43	51	54	48	48	49	52	47	41	49	54	56	52	53	53	58	54	48	55
	810	56	57	48	48	49	49	44	37	45	59	61	53	53	54	55	52	45	51	61	64	59	59	58	62	59	54	57
	1296	62	64	55	53	53	52	49	41	47	65	67	59	59	58	58	56	51	53	67	71	63	62	62	65	63	59	59
200 x 200	324	49	49	39	39	41	43	37	31	40	51	52	46	46	47	50	45	41	47	54	55	49	51	52	56	53	49	53
	540	60	61	48	46	47	47	46	40	46	58	59	52	50	51	54	51	46	51	61	63	55	54	55	59	58	55	57
	864	61	64	52	49	51	50	48	41	47	64	67	57	55	56	56	55	51	53	67	69	62	59	60	63	62	59	59
200 x 150	216	48	47	38	36	39	42	36	29	38	51	50	43	42	44	48	45	39	45	54	54	46	46	48	54	52	47	50
	360	55	55	43	42	45	46	41	36	43	58	58	49	46	48	51	49	45	49	61	61	53	52	53	58	56	54	55
	576	62	62	49	46	48	47	46	41	46	64	66	54	53	53	55	54	51	53	67	68	59	56	58	60	61	59	59

Radiated noise MRP-6

Modell		$D_p = 125 \text{ Pa}$										$D_p = 250 \text{ Pa}$										$D_p = 500 \text{ Pa}$									
		Sound power level L_w [dB/(A)]										Sound power level L_w [dB/(A)]										Sound power level L_w [dB/(A)]									
$B \times H$ [mm]	Q [m ³ /h]	63 Hz	125 Hz	250 Hz	500 Hz	1000 Hz	2000 Hz	4000 Hz	8000 Hz	TOT Hz	63 Hz	125 Hz	250 Hz	500 Hz	1000 Hz	2000 Hz	4000 Hz	8000 Hz	TOT Hz	63 Hz	125 Hz	250 Hz	500 Hz	1000 Hz	2000 Hz	4000 Hz	8000 Hz	TOT Hz			
600 x 300	1944	44	43	38	38	37	33	26	25	33	49	51	44	43	44	40	35	36	40	54	56	49	48	49	46	43	45	45			
	3240	52	51	43	42	41	35	30	29	38	57	56	50	47	46	42	39	38	44	61	62	56	52	51	49	48	47	49			
	5184	58	56	49	46	43	37	33	32	41	63	62	54	52	48	45	42	41	47	68	68	61	55	54	52	49	49	53			
600 x 250	1620	43	43	36	35	35	30	27	25	32	49	50	41	42	41	37	35	35	39	52	56	46	45	45	44	43	44	44			
	2700	52	51	41	39	38	34	31	28	35	56	57	47	45	43	41	39	38	42	60	62	52	49	48	47	47	46	48			
	4320	58	57	46	43	41	35	33	32	39	64	63	54	49	46	44	42	41	46	68	69	59	53	51	51	50	49	52			
600 x 200	1296	42	43	32	32	32	28	25	24	29	47	50	37	37	39	34	33	33	36	51	56	44	41	43	42	41	41	42			
	2160	49	51	37	36	35	31	29	27	33	54	56	43	42	40	37	37	36	39	58	63	49	45	45	44	45	44	45			
	3456	56	56	43	39	37	33	32	30	37	61	64	49	45	42	40	40	39	43	65	68	54	49	49	47	48	48	48			
500 x 300	1620	47	43	39	39	38	34	29	27	35	52	49	45	45	44	42	36	38	41	56	55	52	49	49	48	44	45	47			
	2700	55	49	46	43	41	36	32	31	39	60	56	53	49	47	45	41	40	46	64	62	56	53	52	50	48	48	51			
	4320	61	56	51	46	43	39	33	33	42	66	62	56	53	49	46	42	42	48	71	67	62	57	54	53	52	51	53			
500 x 250	1350	49	48	42	45	49	48	44	38	42	54	54	48	51	55	56	53	47	49	59	59	53	55	61	62	61	54	55			
	2250	57	54	47	49	52	51	46	41	43	63	61	53	55	58	59	55	51	50	67	66	58	59	63	66	63	58	56			
	3600	65	59	52	53	54	54	51	43	44	69	67	58	58	61	61	58	53	51	73	72	63	63	66	68	66	61	57			
500 x 200	1080	45	42	33	34	33	28	26	24	29	49	48	41	38	39	37	34	34	37	54	55	45	43	45	42	42	44	43			
	1800	53	49	39	38	36	31	29	29	34	57	56	45	43	42	39	38	37	40	62	61	52	47	47	46	47	46	47			
	2880	59	55	45	42	38	34	32	31	38	63	61	51	45	44	43	42	40	43	69	68	56	51	49	48	49	48	50			
400 x 300	1296	49	41	41	42	39	36	29	29	37	55	47	48	46	46	42	38	37	43	59	53	53	51	51	50	46	46	49			
	2160	57	46	48	44	43	38	32	32	39	62	54	53	51	48	45	40	41	46	66	59	59	56	53	52	48	49	52			
	3456	64	53	52	48	46	41	35	34	44	69	59	58	55	52	48	44	45	49	73	64	63	58	56	55	51	52	55			



Radiated noise MRP-6

Modell		$D_p = 125 \text{ Pa}$										$D_p = 250 \text{ Pa}$										$D_p = 500 \text{ Pa}$									
		Sound power level L_w [dB/(A)]										Sound power level L_w [dB/(A)]										Sound power level L_w [dB/(A)]									
$B \times H$ [mm]	Q [m ³ /h]	63 Hz	125 Hz	250 Hz	500 Hz	1000 Hz	2000 Hz	4000 Hz	8000 Hz	TOT Hz	63 Hz	125 Hz	250 Hz	500 Hz	1000 Hz	2000 Hz	4000 Hz	8000 Hz	TOT Hz	63 Hz	125 Hz	250 Hz	500 Hz	1000 Hz	2000 Hz	4000 Hz	8000 Hz	TOT Hz			
400 x 250	1080	49	41	39	38	37	34	28	27	34	53	48	45	43	43	41	37	36	41	58	53	51	48	48	47	45	46	47			
	1800	57	46	45	42	40	35	31	32	38	61	54	51	48	47	44	40	40	44	66	59	57	52	51	50	48	49	50			
	2880	62	54	49	45	43	38	34	33	41	68	59	57	52	48	46	44	43	48	72	66	62	55	53	53	52	51	54			
400 x 200	864	48	41	36	34	34	31	27	26	31	53	48	42	39	41	37	35	35	38	58	52	47	45	46	45	43	44	45			
	1440	55	46	42	38	37	33	31	29	35	61	53	47	44	42	40	39	39	41	64	59	54	48	48	47	48	47	48			
	2304	61	53	46	42	39	35	33	33	38	67	59	54	47	45	43	42	42	45	70	66	57	51	50	51	49	50	51			
300 x 200	648	50	38	38	37	37	32	29	29	33	55	45	45	41	42	39	37	37	39	60	51	51	46	47	46	45	46	46			
	1080	58	46	45	40	38	36	31	31	37	64	52	50	45	44	42	41	41	43	68	57	55	51	51	49	48	49	50			
	1728	65	51	49	43	42	38	34	34	40	70	58	56	49	47	45	43	43	47	74	62	61	54	52	52	51	52	53			
300 x 150	486	44	45	38	35	32	28	23	19	30	48	48	43	39	37	35	31	29	36	49	52	48	44	41	41	38	37	41			
	810	52	53	44	39	37	32	27	25	35	54	56	49	44	42	38	35	34	41	57	59	54	49	45	45	43	43	46			
	1296	57	59	51	45	40	35	32	29	41	61	63	55	50	45	41	40	39	46	63	65	59	53	49	47	47	48	50			
200 x 200	324	45	43	35	31	28	27	22	19	27	48	48	41	36	33	33	29	30	33	50	51	46	42	38	39	37	37	39			
	540	51	51	43	36	34	31	27	25	34	55	55	47	42	38	37	36	35	39	57	57	52	46	42	42	42	44	44			
	864	57	58	49	41	38	33	32	30	39	60	62	53	46	43	39	40	39	44	64	65	57	50	47	46	46	48	49			
200 x 150	216	44	43	33	27	26	25	21	19	25	47	46	38	33	31	31	29	28	31	51	49	42	37	35	36	36	37	36			
	360	52	51	39	33	31	28	26	25	31	55	54	44	38	35	34	33	33	36	57	56	49	43	41	41	41	43	42			
	576	58	56	45	37	35	31	31	29	36	60	60	51	43	40	38	38	39	42	63	63	54	48	44	43	45	48	47			

MRP-6-I

Radiated noise MRP-6-I

Modell		$D_p = 125 \text{ Pa}$									$D_p = 250 \text{ Pa}$									$D_p = 500 \text{ Pa}$								
		Sound power level L_w [dB/(A)]									Sound power level L_w [dB/(A)]									Sound power level L_w [dB/(A)]								
$B \times H$ [mm]	Q [m ³ /h]	63 Hz	125 Hz	250 Hz	500 Hz	1000 Hz	2000 Hz	4000 Hz	8000 Hz	TOT Hz	63 Hz	125 Hz	250 Hz	500 Hz	1000 Hz	2000 Hz	4000 Hz	8000 Hz	TOT Hz	63 Hz	125 Hz	250 Hz	500 Hz	1000 Hz	2000 Hz	4000 Hz	8000 Hz	TOT Hz
600 x 300	1944	48	48	42	47	50	49	44	37	41	53	56	48	52	56	57	53	47	49	59	61	53	58	61	63	61	56	55
	3240	57	55	48	52	53	52	47	41	42	61	62	53	60	59	60	56	49	49	65	67	60	61	64	67	64	59	56
	5184	62	62	52	56	55	54	50	43	43	67	68	58	60	61	63	59	53	50	72	73	64	65	67	69	66	61	56
600 x 250	1620	47	48	40	44	48	47	43	36	39	54	58	47	51	56	55	52	47	46	56	61	50	55	58	61	59	55	53
	2700	55	55	46	48	51	50	47	39	40	60	62	51	54	57	57	55	49	48	64	68	56	58	62	64	62	57	54
	4320	62	61	51	53	53	52	49	43	42	68	68	57	58	60	60	58	52	49	72	74	62	62	65	67	66	61	56
600 x 200	1296	42	43	32	32	32	28	25	24	38	51	56	42	46	52	51	49	45	45	56	61	47	50	55	58	57	53	52
	2160	53	56	41	46	48	47	44	39	39	58	62	47	51	53	54	53	48	46	62	58	53	55	58	61	60	56	53
	3456	60	62	46	49	50	51	47	42	40	65	68	54	54	55	57	56	51	47	69	74	58	58	62	64	64	59	54
500 x 300	1620	51	48	43	48	51	50	46	38	43	57	54	49	54	57	58	54	48	49	61	59	55	58	62	64	61	57	56
	2700	59	55	49	52	54	53	48	42	44	64	62	56	58	60	61	58	51	52	68	66	61	62	65	68	64	59	57
	4320	65	61	54	55	56	56	51	45	45	71	66	60	61	62	63	59	54	52	74	72	65	66	67	71	69	63	58
500 x 250	1350	49	48	42	45	49	48	43	38	42	54	54	48	51	56	56	52	48	49	59	59	53	55	61	62	60	55	55
	2250	57	55	46	49	52	51	46	41	43	62	61	53	55	58	59	56	51	50	68	66	59	59	62	66	63	58	56
	3600	65	59	51	53	54	54	51	43	44	69	67	58	58	61	61	58	53	51	74	72	63	63	66	68	67	62	57
500 x 200	1080	49	47	38	42	46	45	42	36	40	53	53	45	47	52	54	51	45	48	58	59	49	52	57	59	58	55	54
	1800	56	55	44	46	49	48	46	39	41	62	60	49	51	55	56	54	49	48	65	66	56	56	61	63	62	57	55
	2880	63	61	48	50	51	51	48	43	42	68	66	55	54	57	59	57	52	49	72	72	61	59	62	65	64	59	56
400 x 300	1296	54	46	45	51	52	52	46	41	46	59	53	52	56	58	59	55	49	52	63	57	57	61	64	66	62	58	58
	2160	61	52	51	53	56	55	49	44	47	67	58	57	59	62	62	57	52	53	71	65	63	64	66	69	65	61	60
	3456	68	58	56	57	58	57	53	46	47	73	65	62	63	64	65	62	55	55	77	69	67	68	68	71	68	64	60



Radiated noise MRP-6-I

Modell		$D_p = 125 \text{ Pa}$										$D_p = 250 \text{ Pa}$										$D_p = 500 \text{ Pa}$									
		Schallleistungspegel L_w [dB/(A)]										Schallleistungspegel L_w [dB/(A)]										Schallleistungspegel L_w [dB/(A)]									
$B \times H$ [mm]	Q [m ³ /h]	63 Hz	125 Hz	250 Hz	500 Hz	1000 Hz	2000 Hz	4000 Hz	8000 Hz	TOT Hz	63 Hz	125 Hz	250 Hz	500 Hz	1000 Hz	2000 Hz	4000 Hz	8000 Hz	TOT Hz	63 Hz	125 Hz	250 Hz	500 Hz	1000 Hz	2000 Hz	4000 Hz	8000 Hz	TOT Hz			
400 x 250	1080	53	46	43	48	51	50	44	39	44	58	52	49	52	56	57	53	48	51	62	58	54	57	61	64	62	56	58			
	1800	60	52	48	51	53	52	48	42	45	65	59	55	56	59	61	56	52	52	70	65	61	61	64	67	64	59	59			
	2880	67	58	53	54	56	55	51	44	46	73	64	61	60	61	63	59	54	53	76	71	65	64	67	71	67	62	60			
400 x 200	864	51	46	40	44	47	47	43	38	43	56	53	46	48	54	54	52	46	48	62	58	52	53	59	61	59	56	56			
	1440	59	52	46	47	50	50	47	41	44	64	58	52	52	55	57	55	51	50	68	65	57	57	62	64	63	58	57			
	2304	66	58	51	52	52	52	49	44	44	72	65	57	56	58	61	58	53	51	75	71	61	60	63	67	65	62	58			
300 x 200	648	54	44	43	45	49	49	44	39	46	59	49	49	51	55	56	53	48	53	65	55	54	56	60	63	61	57	59			
	1080	62	51	48	49	51	52	47	43	46	67	56	55	54	57	59	57	53	53	72	63	59	59	64	66	64	61	60			
	1728	69	55	53	52	54	56	51	45	47	74	63	59	58	61	62	59	55	54	78	67	64	64	65	59	68	64	61			
300 x 150	486	48	49	43	43	44	46	39	31	43	51	54	48	48	49	52	47	41	49	54	56	52	53	53	58	54	48	55			
	810	56	57	48	48	49	49	44	37	45	59	61	53	53	54	55	52	45	51	61	64	59	59	58	62	59	54	57			
	1296	62	64	55	53	53	52	49	41	47	65	67	59	59	58	58	56	51	53	67	71	63	62	62	65	63	59	59			
200 x 200	324	49	49	39	39	41	43	37	31	40	51	52	46	46	47	50	45	41	47	54	55	49	51	52	56	53	49	53			
	540	60	61	48	46	47	47	46	40	46	58	59	52	50	51	54	51	46	51	61	63	55	54	55	59	58	55	57			
	864	61	64	52	49	51	50	48	41	47	64	67	57	55	56	56	55	51	53	67	69	62	59	60	63	62	59	59			
200 x 150	216	48	47	38	36	39	42	36	29	38	51	50	43	42	44	48	45	39	45	54	54	46	46	48	54	52	47	50			
	360	55	55	43	42	45	46	41	36	43	58	58	49	46	48	51	49	45	49	61	61	53	52	53	58	56	54	55			
	576	62	62	49	46	48	47	46	41	46	64	66	54	53	53	55	54	51	53	67	68	59	56	58	60	61	59	59			

MRP-6-I

Radiated noise MRP-6-I

Modell		$D_p = 125 \text{ Pa}$										$D_p = 250 \text{ Pa}$										$D_p = 500 \text{ Pa}$									
		Sound power level L_w [dB/(A)]										Sound power level L_w [dB/(A)]										Sound power level L_w [dB/(A)]									
$B \times H$ [mm]	Q [m ³ /h]	63 Hz	125 Hz	250 Hz	500 Hz	1000 Hz	2000 Hz	4000 Hz	8000 Hz	TOT Hz	63 Hz	125 Hz	250 Hz	500 Hz	1000 Hz	2000 Hz	4000 Hz	8000 Hz	TOT Hz	63 Hz	125 Hz	250 Hz	500 Hz	1000 Hz	2000 Hz	4000 Hz	8000 Hz	TOT Hz			
600 x 300	1944	42	41	31	28	25	21	15	16	24	47	48	38	33	32	28	24	27	29	52	53	43	38	37	34	32	35	36			
	3240	49	48	37	33	28	23	20	21	28	54	53	43	37	35	31	28	29	35	58	59	49	43	39	37	36	38	41			
	5184	55	53	42	36	31	25	23	23	33	61	59	48	42	36	33	32	33	39	65	65	54	46	42	40	38	41	45			
600 x 250	1620	40	40	29	26	23	18	15	17	22	45	48	35	32	29	25	23	26	29	49	53	40	35	33	32	31	35	34			
	2700	48	47	36	29	26	22	18	19	27	53	53	42	35	31	29	27	29	33	57	59	46	39	37	35	34	38	39			
	4320	55	53	41	33	28	23	22	23	31	62	61	47	39	34	32	30	32	38	65	67	52	43	39	38	38	41	44			
600 x 200	1296	38	41	26	22	21	15	<15	16	20	44	47	32	27	26	23	22	24	26	48	53	37	32	30	29	29	33	32			
	2160	46	18	32	26	23	19	17	19	25	52	54	37	31	28	25	25	28	31	55	59	43	36	33	32	33	35	37			
	3456	53	53	36	29	26	22	19	22	30	58	61	43	35	31	28	28	30	37	62	65	49	39	36	35	36	38	42			
500 x 300	1620	44	39	34	29	26	22	17	19	25	49	46	39	35	32	29	26	28	31	53	51	46	39	37	35	33	37	37			
	2700	52	47	39	33	29	25	21	22	28	58	54	46	39	35	32	29	32	36	61	59	51	43	40	38	37	39	41			
	4320	58	52	44	36	32	28	22	25	33	63	58	51	42	37	34	31	34	40	67	65	55	47	43	41	40	43	45			
500 x 250	1350	42	39	32	26	24	19	16	17	23	47	46	38	32	31	27	24	27	30	53	52	42	36	35	33	32	35	35			
	2250	50	46	37	31	26	22	19	20	27	55	52	44	36	33	31	27	30	34	61	58	48	41	37	36	35	39	39			
	3600	57	52	41	34	29	25	22	23	31	62	58	49	39	35	32	31	32	38	67	65	52	44	41	39	38	41	44			
500 x 200	1080	41	39	27	23	22	16	<15	16	20	46	45	35	28	27	25	22	26	27	50	51	39	34	32	31	31	34	33			
	1800	49	46	33	28	23	19	17	19	25	54	53	39	32	29	28	26	29	31	58	58	45	38	35	34	34	38	38			
	2880	56	52	38	32	26	23	21	22	30	61	58	44	36	32	31	29	31	36	65	64	51	40	37	36	36	39	42			
400 x 300	1296	46	38	35	32	27	23	18	21	26	52	45	42	36	34	31	26	28	33	56	49	47	42	39	38	34	37	39			
	2160	54	43	42	34	31	26	21	23	30	59	51	47	41	36	33	29	32	37	63	56	54	45	42	40	37	41	43			
	3456	61	49	47	38	33	28	24	26	35	66	56	52	45	39	36	33	35	41	70	62	57	48	43	42	41	43	46			



Radiated noise MRP-6-I

Modell		$D_p = 125 \text{ Pa}$										$D_p = 250 \text{ Pa}$										$D_p = 500 \text{ Pa}$									
		Sound power level L_w [dB/(A)]										Sound power level L_w [dB/(A)]										Sound power level L_w [dB/(A)]									
$B \times H$ [mm]	Q [m ³ /h]	63 Hz	125 Hz	250 Hz	500 Hz	1000 Hz	2000 Hz	4000 Hz	8000 Hz	TOT Hz	63 Hz	125 Hz	250 Hz	500 Hz	1000 Hz	2000 Hz	4000 Hz	8000 Hz	TOT Hz	63 Hz	125 Hz	250 Hz	500 Hz	1000 Hz	2000 Hz	4000 Hz	8000 Hz	TOT Hz			
400 x 250	1080	45	38	33	28	26	21	17	18	24	50	44	39	33	31	28	25	28	30	55	49	45	38	36	35	33	37	37			
	1800	53	43	39	32	29	23	19	23	28	58	51	45	37	34	31	28	31	35	63	56	51	42	39	38	36	39	41			
	2880	59	51	43	35	30	26	22	25	32	58	51	45	38	34	32	28	32	35	69	62	55	46	42	41	39	43	45			
400 x 200	864	44	38	31	24	22	18	16	17	21	49	45	36	29	28	25	23	26	28	54	49	42	34	34	32	31	36	34			
	1440	52	43	35	28	25	21	19	20	26	57	51	41	33	30	28	27	31	32	61	56	48	38	36	35	35	39	38			
	2304	58	49	41	32	27	23	21	23	30	64	56	48	37	33	32	30	33	37	67	62	52	41	38	38	37	42	42			
300 x 200	648	48	36	33	26	24	21	16	20	23	53	41	38	32	30	27	25	28	29	57	48	44	36	35	34	33	37	36			
	1080	56	42	38	31	27	24	20	23	27	60	48	44	36	32	30	28	33	34	65	55	49	41	38	37	36	41	40			
	1728	62	47	43	33	29	27	23	25	32	67	54	50	39	35	33	31	35	38	71	59	54	45	41	40	39	44	44			
300 x 150	486	41	41	32	24	19	17	15	<15	22	44	45	38	29	24	23	19	21	27	46	48	42	34	228	29	26	28	31			
	810	48	49	39	29	24	21	15	17	28	51	53	43	34	29	26	23	25	32	53	56	48	39	33	33	32	34	37			
	1296	54	56	45	34	28	23	20	21	34	57	59	49	39	34	29	28	30	38	59	63	53	43	37	35	35	40	42			
200 x 200	324	42	41	29	20	16	15	<15	<15	19	44	44	36	26	21	21	18	20	25	47	47	39	32	26	27	25	29	30			
	540	48	48	36	27	22	19	15	16	26	51	52	41	31	26	24	23	26	31	54	54	46	35	30	30	31	34	35			
	864	55	55	42	31	26	21	19	20	32	57	59	47	36	31	27	28	30	37	60	62	51	40	35	34	34	39	41			
200 x 150	216	41	39	27	18	15	<15	<15	<15	18	44	42	32	23	19	19	17	18	22	47	46	36	28	23	24	23	28	27			
	360	48	47	33	24	19	16	<15	16	24	51	50	38	27	24	22	21	25	28	54	53	43	32	28	28	28	34	33			
	576	54	53	39	28	23	18	18	21	30	57	57	44	34	27	26	26	31	35	60	60	48	37	33	31	33	39	39			

FLOW RATE RANGE IN RELATION TO DUCT CROSS SECTION

Flow rate calibration possible at air velocities from 3 to 8 m/s.

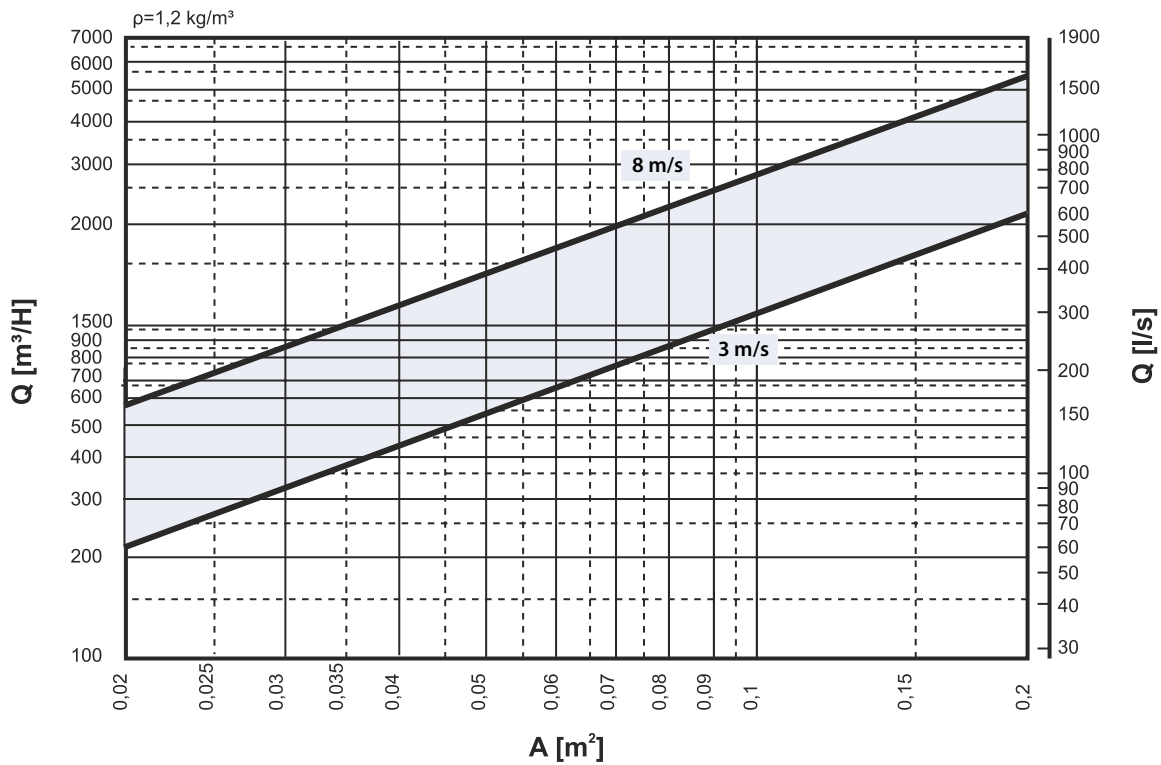

Minimum static pressure difference at the regulator.

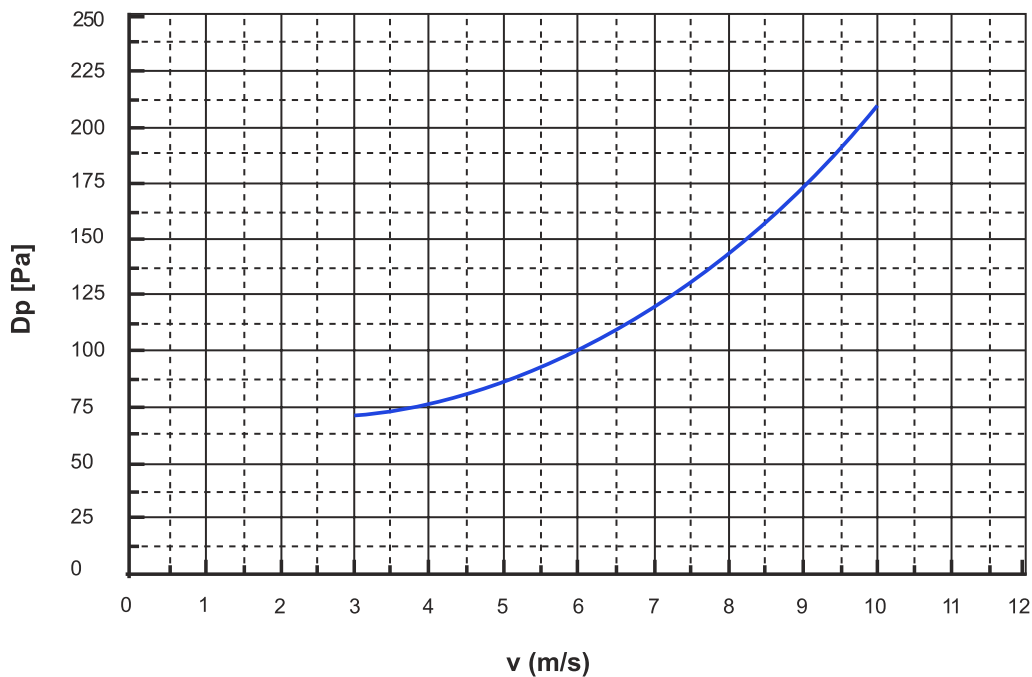

Legend:

Q [m ³ /h or l/s]	flow rate
v [m/s]	air velocity
A [m ²]	effective outlet area
D_p [Pa]	static pressure difference

Installation

Rectangular controllers are flanged on both sides for connection with the standard 30 mm ventilation duct flange. The controller can be installed in horizontal, vertical or inclined mounted duct in a manner that the rotational axis of the dampe blade is always in a horizontal position. Also it is necessary to pay attention to the correct mounting direction shown with the air flow direction arrow on the controller. Required length of the straight duct section is $L_{\min} > 3 d_{ek}$ before and $L_{\min} > 1,5 d_{ek}$ after the the controller. If this lengths are smaller, deviations of the set flow rate can occure and the stated accuracy of the flow rate may not be achived; therefore, such installations are not recommended. Controllers are maintenance free.

